



# HEIDENHAIN



## Inverter Systems

For HEIDENHAIN Controls

Information for the Machine  
Tool Builder

# HEIDENHAIN inverter systems

The inverter systems from HEIDENHAIN are suitable for the HEIDENHAIN controls with digital speed control. They are designed for operating the synchronous and asynchronous motors from HEIDENHAIN.

## Intended use

The products described in this brochure

- may be used only for NC controlled machine tools
- must be used only in an industrial environment, for commercial applications and in research facilities
- may be operated only in accordance with the product specifications (technical data, ambient data, safety instructions, etc.)
- may be operated only in an electrical cabinet

For the use of the devices as part of a safety function, the machine manufacturer must ensure that the end product meets all requirements of the Machinery Directive (2006/42/EC).

## Improper use

The devices are not intended for applications in areas where a failure would result in considerable risks for humans or the environment.

Use in potentially explosive atmospheres is prohibited.



**MC 6641, CC 6108**  
with modular inverters

## System tests

Controls, inverters, motors and encoders from HEIDENHAIN are usually integrated as components in larger systems. In these cases, comprehensive tests of the complete system are required, irrespective of the specifications of the individual devices.

## Expendable parts

In particular fans in inverters from HEIDENHAIN are subject to wear.

## Standards

Standards (ISO, EN, etc.) apply only where explicitly stated in the catalog.

# Contents

	Page
<b>Inverter systems</b>	<b>4</b>
<b>Overview</b>	<b>7</b>
<b>Compact inverters</b>	<b>8</b>
<b>Modular inverters</b>	<b>16</b>
<b>Accessories for inverter systems</b>	<b>22</b>
<b>Ribbon cables and covers</b>	<b>29</b>
<b>Double-row configuration</b>	<b>34</b>
<b>Overview of cables for inverters</b>	<b>40</b>
<b>Mounting information</b>	<b>41</b>
<b>Dimensions</b>	<b>43</b>
<b>Subject index</b>	<b>63</b>

This catalog supersedes all previous editions, which thereby become invalid.

**Subject to change without notice**

# HEIDENHAIN inverter systems

HEIDENHAIN inverter systems are designed for use with QSY synchronous motors and QAN asynchronous motors from HEIDENHAIN. The inverter systems are available with power ratings of 14 kW to 125 kW. They can be supplied as compact inverters or in modular versions as regenerative or non-regenerative systems.

Regenerative inverters

In the **energy-recovery inverters**, the braking energy of the motors is normally returned to line power. Regenerative systems need additional components, such as line **filters** and **commutating reactors** (see *Accessories for inverter systems*).

Non-regenerative inverters

With **non-regenerative inverters**, the braking energy of the motors is converted to heat. This requires a **braking resistor** (see *Accessories for inverter systems*).

Supply voltage

Please refer to the following tables for the respective supply voltage. The inverter systems are designed for connection to a TN public power grid. Other public grids or other line voltages must be adapted over a transformer.

DC-link voltage

Both inverter systems use a rectifier bridge circuit to convert the line power to the DC-link voltage and other auxiliary voltages for the electronics of the power modules, the controller unit, and the main computer. The rectified and—for regenerative systems—controlled DC-link voltage is conducted through IGBTs to the motors under frequency and voltage control. Control is by PWM signals.

The DC-link voltage is DC 565 V for non-regenerative systems and DC 650 V for regenerative systems.

Safety functions

In the event of an emergency stop, HEIDENHAIN inverter systems make it possible to shut down the motors centrally over special inputs for deleting the pulse release for PWM control of the IGBTs. The controller unit controls the emergency-stop braking until standstill.

If required, however, drive groups can be formed in order to switch them off separately (e.g. axes for the tool magazine). On controls without functional safety, the axes are then switched off through an **axis-release module**.

Functional safety (FS)

HEIDENHAIN offers control systems with functional safety (FS). Controls with HSCI, the uniformly digital control design from HEIDENHAIN, are the foundation for this.

Control systems with functional safety have two redundant safety channels that operate completely independently of each other. They capture, process and output all safety-relevant signals in two channels. Only those inverters and supply modules that have been certified for functional safety may be used in FS control systems. Please take this into account when configuring your machine and in case servicing is required.

Inverter components for functional safety are identified as such in this brochure.

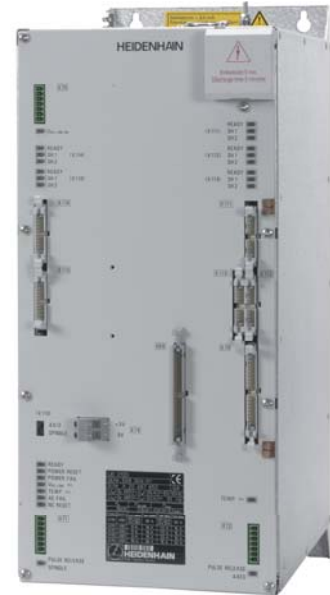

UE 212D



UR 242D

Compact inverters In a single enclosure, **UE, UR** and **UEC** compact inverters house the rectifiers for generating the DC-link voltage and the IGBT full bridges for up to five drives. Compact inverters with internal braking resistor are available for power ratings up to 22 kW. As an alternative, the internal braking resistor can be replaced by an external resistor to reduce heat generation in the electrical cabinet (but not with UE 11x). Higher power ratings require regenerative systems.

For special cases, additional power modules can be connected to a compact inverter (not with UE 11x). Please note that the total power consumption of the connected motors must not exceed the power rating of the compact inverter!

The CC controller unit of the **UE** and **UR** is connected to the compact inverter over a ribbon cable and uses PWM signals to control the IGBTs.



UVR 140D

Modular inverters Modular inverter systems consist of the following modules:

- One **UV** or **UVR power supply unit** including the necessary additional components
- Several **UM power modules** for axes and spindle
- **Ribbon cables and covers**

In modular systems, the power supply unit produces the rectified DC-link voltage. The IGBT full bridges are housed in the separate **UM** power modules. The DC-link power bar conducts the DC-link voltage to the power modules.

The CC controller unit is connected to the power modules over a ribbon cable and uses PWM signals to control the IGBTs. The power supply unit is arranged the farthest to the left. The power modules are arranged to the right in order of decreasing power rating.

Additional power supply Compact inverters and power supply units have a DC 5V output (connector X74) in addition to the supply bus (connector X69). It additionally supplies the CC and thus also the connected encoders with power.

Safety parameters For HEIDENHAIN products (such as control components, encoders or motors), the product-specific safety characteristics (such as failure rates, statements on fault exclusion) are available on request from your HEIDENHAIN contact person.



UM 115D

Power supply voltage for connected modules

The current consumption for the electronics of the modular inverters depends largely on their power output. If several high-capacity modules are used, in rare cases the maximum permissible current from the power supply unit might be exceeded. Therefore, be sure to check the current consumption for the DC 15 V and DC 24 V supplies individually. The supply unit's own current consumption also has to be taken into account. The data specified in the specifications for current consumption apply for PWM frequencies up to 5 kHz. For PWM frequencies from 5 kHz to 10 kHz, the given values must be multiplied by the following factor:

$$\sqrt{\frac{f}{5 \text{ kHz}}}$$

If the total current consumption exceeds the maximum value, an MS 111 must be used with the provision of external +24 V.

The UV(R) supply units have an additional integrated power pack that supplies the following voltages for the control system:

- DC 5 V NC for supply of the CC controller unit and connected encoders (connector X74)
- DC 15 V and DC 24 V for supply of the connected inverters (connector X79)
- DC 24 V NC for supply of the HSCI components (connector X90, protective extra-low voltage, safely separated)
- *Only on UVR 170D(W), UV 130D:* DC 24 V PLC for supply of the PLC components (connector X90, basic insulation)

The integrated power pack is buffered via the DC link, thereby ensuring that in the event of a power failure the connected components will continue to be supplied so that concluding actions, such as the LIFTOFF function, can be performed. The power failure must be considered separately. As a machine tool builder, you should—where required—take into account measures to be taken regarding a power failure.

The performance data of the power pack can be found in the Specifications. During planning, please also consider the power requirements of the connected inverters, encoders, and controller units in addition to the HSCI/PLC components. In rare cases it may be necessary to use an additional external power supply unit, such as a PSL 130, if the power output of the integrated power pack does not suffice. For further information on project planning, refer to the *Inverter Systems and Motors* Technical Manual.

For the entire HSCI system, the +24 V NC supply voltage is required to be safely separated voltage. Safely separated circuits or circuits with basic insulation must not be mixed or connected with each other.

Motor currents

The power modules and compact inverters are available in gradations to make it possible to match them to the required motor currents and torques. In addition, the PWM frequency can be adjusted to the motor current. Please remember that very high spindle speeds require a higher PWM frequency (see *Spindle*).

Ribbon cables and covers

The individual control components are connected through ribbon cables for PWM signals, supply bus and unit bus. The ribbon cables must be covered to protect against interference. Ribbon cables and covers must be ordered in the required lengths.

The ribbon cables and standard covers for compact inverters are included in delivery.

# Overview

	Type	Rated power	Rated current <sup>1)</sup>		Page
			Axes	Spindle/Axis <sup>2)</sup>	
<b>Compact inverters</b>					
Regenerative	<b>UR 230 D</b>	22 kW	2 x 7.5 A	1 x 35/25 A	<b>8</b>
	<b>UR 240 D</b>	22 kW	3 x 7.5 A	1 x 35/25 A	
	<b>UR 242 D</b>	22 kW	3 x 7.5 A	2 x 35/25 A	
Non-regenerative	<b>UE 210 D</b>	15 kW	3 x 7.5 A	1 x 20/15 A	<b>10</b>
	<b>UE 211 D</b>	15 kW	2 x 7.5 A + 1 x 15 A	1 x 20/15 A	
	<b>UE 212 D</b>	15 kW	3 x 7.5 A + 1 x 15 A	1 x 20/15 A	<b>12</b>
	<b>UE 230 D</b>	22 kW	2 x 7.5 A	1 x 31/23 A	
	<b>UE 240 D</b>	22 kW	3 x 7.5 A	1 x 31/23 A	
	<b>UE 241 D</b>	22 kW	2 x 7.5 A + 1 x 23 A	1 x 31/23 A	
	<b>UE 242 D</b>	22 kW	3 x 7.5 A + 1 x 23 A	1 x 31/23 A	
Non-regenerative, integrated controller unit	<b>UEC 111</b>	14 kW	2 x 6 A + 1 x 9 A	1 x 24/- A	<b>15</b>
	<b>UEC 112</b>	14 kW	3 x 6 A + 1 x 9 A	1 x 24/- A	
	<b>UEC 113</b>	14 kW	4 x 6 A + 1 x 9 A	1 x 24/- A	
	<b>UMC 111 FS</b>	14 kW	4 x 9 A	-	
<b>Modular inverters</b>					
<b>Power module</b> For one axis	<b>UM 111 D</b>	-	1 x 7.5 A	-	<b>17</b>
	<b>UM 111 BD</b>	-	-	1 x 20/15 A	
	<b>UM 112 D</b>	-	-	1 x 34/25 A	
	<b>UM 113 D</b>	-	-	1 x 56/40 A	
	<b>UM 114 D</b>	-	-	1 x 90/60 A	
	<b>UM 115 D</b>	-	-	1 x 125/96 A	
	<b>UM 116 D</b>	-	-	1 x 210/150 A	
	<b>UM 116 DW</b>	-	-	1 x 210/150 A	
	<b>UM 117 DW</b>	-	-	1 x 320/225 A	
For two axes	<b>UM 121 D</b>	-	2 x 7.5 A	-	<b>19</b>
	<b>UM 121 BD</b>	-	1 x 15 A	1 x 20/15 A	
	<b>UM 122 D</b>	-	1 x 25 A	1 x 34/25 A	
<b>Supply unit</b> Regenerative	<b>UVR 120 D</b>	22 kW	-	-	<b>20</b>
	<b>UVR 130 D</b>	30 kW	-	-	
	<b>UVR 140 D</b>	45 kW	-	-	
	<b>UVR 150 D</b>	55 kW	-	-	
	<b>UVR 160 D</b>	80 kW	-	-	
	<b>UVR 160 DW</b>	80 kW	-	-	
	<b>UVR 170 D</b>	125 kW	-	-	
	<b>UVR 170 DW</b>	125 kW	-	-	
Non-regenerative	<b>UV 130 D</b>	30 kW	-	-	<b>21</b>

<sup>1)</sup> At PWM frequency of 5 kHz, except for UEC 1xx, where the PWM frequency is 3.33 kHz

<sup>2)</sup> Depending on whether the Axis or Spindle mode of operation is selected

# Compact inverters

## Regenerative

Regenerative compact inverters		2 axes and spindle or 3 axes		3 axes and spindle or 4 axes	
		UR 230D		UR 240D	
		2 axes	Spindle/Axis	3 axes	Spindle/Axis
<b>Rated current <math>I_N</math></b> <i>S6-40 %</i> <sup>1)</sup> <b>Maximum current</b> $I_{max}$ <sup>2)</sup> at PWM frequency	3 333 Hz	9.0 A – 18.0 A	42.0 A/30.0 A 60.0 A/– 60.0 A/60.0 A	9.0 A – 18.0 A	42.0 A/30.0 A 60.0 A/– 60.0 A/60.0 A
	4 000 Hz	8.3 A – 16.5 A	38.5 A/27.5 A 55.0 A/– 55.0 A/55.0 A	8.3 A – 16.5 A	38.5 A/27.5 A 55.0 A/– 55.0 A/55.0 A
	<b>5 000 Hz</b>	<b>7.5 A</b> – <b>15.0 A</b>	<b>35.0 A/25.0 A</b> <b>50.0 A/–</b> <b>50.0 A/50.0 A</b>	<b>7.5 A</b> – <b>15.0 A</b>	<b>35.0 A/25.0 A</b> <b>50.0 A/–</b> <b>50.0 A/50.0 A</b>
	6 666 Hz	6.3 A – 12.6 A	29.4 A/21.0 A 42.0 A/– 42.0 A/42.0 A	6.3 A – 12.6 A	29.4 A/21.0 A 42.0 A/– 42.0 A/42.0 A
	8 000 Hz	5.5 A – 11.0 A	25.6 A/18.3 A 36.5 A/– 36.5 A/36.5 A	5.5 A – 11.0 A	25.6 A/18.3 A 36.5 A/– 36.5 A/36.5 A
	10 000 Hz	4.6 A – 9.2 A	21.4 A/15.3 A 30.5 A/– 30.5 A/30.5 A	4.6 A – 9.2 A	21.4 A/15.3 A 30.5 A/– 30.5 A/30.5 A
<b>Supply voltage</b>	3AC 400 V (±10 %); 50 Hz to 60 Hz		3AC 400 V (±10 %); 50 Hz to 60 Hz		
<b>Rated power</b> of DC link	<b>22 kW</b>		<b>22 kW</b>		
<b>Peak power</b> <sup>3)</sup> of DC link	30 kW / 40 kW		30 kW / 40 kW		
<b>Power loss</b> <sup>4)</sup> at $I_N$	≈ 680 W		≈ 750 W		
<b>DC-link voltage</b>	DC 650 V		DC 650 V		
<b>Module width</b>	250 mm		250 mm		
<b>Mass</b>	≈ 22.5 kg		≈ 22.5 kg		
<b>Functional safety</b>	✓		✓		
<b>ID</b>	741356-xx		741357-xx		

**Additional components for regenerative compact inverters** (see *Accessories for inverters*)

<b>Commutating reactor</b>	KDR 120	KDR 120
<b>Line filter</b>	EPCOS 35A	EPCOS 35A
<b>Braking resistor</b>	UP 110	UP 110
<b>DC-link filter</b> <sup>5)</sup>	ZKF 110 or ZKF 120	ZKF 110 or ZKF 120
<b>Surge protector</b>	VALMS 230/FM	VALMS 230/FM
<b>Voltage protection module</b> <sup>6)</sup>	SM 110	SM 110

1) Spindle: 40 % cyclic duration factor for cycle duration of 10 minutes (S6-40 %)

2) Axis: 0.2 s cyclic duration factor for cycle duration of 10 s with 70 % rated current preload  
 Spindle: 10 s cyclic duration factor for cycle duration of 60 s with 70 % rated current preload



**4 axes and spindle or 5 axes**

**UR 242D**

3 axes	1 axis/spindle	Spindle/Axis
9.0 A – 18.0 A	30.0 A/42.0 A 60.0 A/– 60.0 A/60.0 A	42.0 A/30.0 A 60.0 A/– 60.0 A/60.0 A
8.3 A – 16.5 A	27.5 A/38.5 A 55.0 A/– 55.0 A/55.0 A	38.5 A/27.5 A 55.0 A/– 55.0 A/55.0 A
<b>7.5 A</b> – <b>15.0 A</b>	<b>25.0 A/35.0 A</b> <b>50.0 A/–</b> <b>50.0 A/50.0 A</b>	<b>35.0 A/25.0 A</b> <b>50.0 A/–</b> <b>50.0 A/50.0 A</b>
6.3 A – 12.6 A	21.0 A/29.5 A 42.0 A/– 42.0 A/42.0 A	29.4 A/21.0 A 42.0 A/– 42.0 A/42.0 A
5.5 A – 11.0 A	18.3 A/25.6 A 36.5 A/– 36.5 A/36.5 A	25.6 A/18.3 A 36.5 A/– 36.5 A/36.5 A
4.6 A – 9.2 A	15.3 A/21.4 A 30.5 A/– 30.5 A/30.5 A	21.4 A/15.3 A 30.5 A/– 30.5 A/30.5 A

3AC 400 V (±10 %); 50 Hz to 60 Hz

**22 kW**

30 kW / 40 kW

≈ 930 W

DC 650 V

250 mm

≈ 22.5 kg

✓

741359-xx

KDR 120

EPCOS 35A

UP 110

ZKF 110 or ZKF 120

VALMS 230/FM

SM 110

<sup>3)</sup> 1st value: 40 % cyclic duration factor for cycle duration of 10 minutes (S6-40 %) <sup>5)</sup> Only for direct drives with the use of an additional UM 1xxD  
2nd value: 0.2 s cyclic duration factor for cycle duration of 5 s

<sup>4)</sup> Power loss during idle running: approx. 10 % of the power loss at rated current <sup>6)</sup> Only for synchronous or torque motors with field weakening

# Compact inverters

## Non-regenerative

Non-regenerative compact inverters (continued on next double-page spread)		3 axes and spindle				
		UE 210 D		UE 211 D		
		3 axes	Spindle/Axis	2 axes	1 axis	Spindle/Axis
<b>Rated current <math>I_N</math></b> <i><math>I_{S6-40}</math></i> <sup>1)</sup>	3 333 Hz	9.0 A	24.0 A/18.0 A	9.0 A	18.0 A	24.0 A/18.0 A
		–	36.0 A/–	–	–	36.0 A/–
<b>Maximum current <math>I_{max}</math></b> <sup>2)</sup> at PWM frequency		18.0 A	36.0 A/36.0 A	18.0 A	36.0 A	36.0 A/36.0 A
	4 000 Hz	8.3 A – 16.5 A	22.0 A/16.5 A 33.0 A/– 33.0 A/33.0 A	8.3 A – 16.5 A	16.5 A – 33.0 A	22.0 A/16.5 A 33.0 A/– 33.0 A/33.0 A
	<b>5 000 Hz</b>	<b>7.5 A</b> – <b>15.0 A</b>	<b>20.0 A/15.0 A</b> <b>30.0 A/–</b> <b>30.0 A/30.0 A</b>	<b>7.5 A</b> – <b>15.0 A</b>	<b>15.0 A</b> – <b>30.0 A</b>	<b>20.0 A/15.0 A</b> <b>30.0 A/–</b> <b>30.0 A/30.0 A</b>
	6 666 Hz	6.3 A – 12.6 A	16.8 A/12.6 A 25.2 A/– 25.2 A/25.2 A	6.3 A – 12.6 A	12.6 A – 25.2 A	16.8 A/12.6 A 25.2 A/– 25.2 A/25.2 A
	8 000 Hz	5.5 A – 11.0 A	14.6 A/11.0 A 22.0 A/– 22.0 A/22.0 A	5.5 A – 11.0 A	11.0 A – 22.0 A	14.6 A/11.0 A 22.0 A/– 22.0 A/22.0 A
	10 000 Hz	4.6 A – 9.2 A	12.2 A/9.1 A 18.2 A/– 18.2 A/18.2 A	4.6 A – 9.2 A	9.1 A – 18.2 A	12.2 A/9.1 A 18.2 A/– 18.2 A/18.2 A
<b>Supply voltage</b>		3AC 400 V ( $\pm 10$ %); 50 Hz to 60 Hz or 3AC 480 V (+6 %/-10 %); 50 Hz to 60 Hz		3AC 400 V ( $\pm 10$ %); 50 Hz to 60 Hz or 3AC 480 V (+6 %/-10 %); 50 Hz to 60 Hz		
<b>Rated power</b> of DC link		<b>15 kW</b>		<b>15 kW</b>		
<b>Peak power</b> <sup>3)</sup> of DC link		23 kW / 40 kW		23 kW / 40 kW		
<b>Power loss</b> <sup>4)</sup> at $I_N$		≈ 475 W		≈ 525 W		
<b>DC-link voltage</b>		DC 565 V		DC 565 V		
<b>Integral braking resistor</b> <sup>5)</sup>		1 kW / 27 kW		1 kW / 27 kW		
<b>Module width</b>		200 mm		200 mm		
<b>Mass</b>		≈ 20 kg		≈ 20 kg		
<b>Functional safety</b>		✓		✓		
<b>ID</b>		733421-xx		733423-xx		
<b>Additional components for non-regenerative compact inverters</b> (see <i>Accessories for inverters</i> )						
<b>Braking resistor</b>		PW 210		PW 210		
<b>Surge protector</b>		VALMS 230/FM		VALMS 230/FM		
<b>Voltage protection module</b> <sup>6)</sup>		SM 110		SM 110		

<sup>1)</sup> Spindle: 40 % cyclic duration factor for cycle duration of 10 minutes (S6-40 %)

<sup>2)</sup> Axis: 0.2 s cyclic duration factor for cycle duration of 10 s with 70 % rated current preload  
Spindle: 10 s cyclic duration factor for cycle duration of 60 s with 70 % rated current preload

<sup>3)</sup> 1st value: 40 % cyclic duration factor for cycle duration of 10 minutes (S6-40 %)

2nd value: 0.2 s cyclic duration factor for cycle duration of 5 s

**4 axes and spindle or 5 axes**

**UE 212D**

3 axes	1 axis	Spindle/Axis
9.0 A <i>18.0 A</i> 18.0 A	18.0 A – 36.0 A	24.0 A/18.0 A <i>36.0 A/–</i> 36.0 A/36.0 A
8.3 A <i>16.5 A</i> 16.5 A	16.5 A – 33.0 A	22.0 A/16.5 A <i>33.0 A/–</i> 33.0 A/33.0 A
<b>7.5 A</b> <b>15.0 A</b> <b>15.0 A</b>	<b>15.0 A</b> – <b>30.0 A</b>	<b>20.0 A/15.0 A</b> <b>30.0 A/–</b> <b>30.0 A/30.0 A</b>
6.3 A <i>12.6 A</i> 12.6 A	12.6 A – 25.2 A	16.8 A/12.6 A <i>25.2 A/–</i> 25.2 A/25.2 A
5.5 A <i>11.0 A</i> 11.0 A	11.0 A – 22.0 A	14.6 A/11.0 A <i>22.0 A/–</i> 22.0 A/22.0 A
4.6 A <i>9.2 A</i> 9.2 A	9.1 A – 18.2 A	12.2 A/9.1 A <i>18.2 A/–</i> 18.2 A/18.2 A

3AC 400 V (±10 %); 50 Hz to 60 Hz  
or 3AC 480 V (+6 %/-10 %); 50 Hz to 60 Hz

**15 kW**

23 kW / 40 kW

≈ 595 W

DC 565 V

1 kW / 27 kW

200 mm

≈ 20 kg

✓

733424-xx

PW 210

VAL-MS 230/FM

SM 110

<sup>4)</sup> Power loss during idle running: approx. 10 % of the power loss at rated current

<sup>5)</sup> 1st value: Continuous power

2nd value: 1.5 % cyclic duration factor for cycle duration of 120 s

<sup>6)</sup> Only for synchronous or torque motors with field weakening

# Compact inverters

## Non-regenerative

Non-regenerative compact inverters		2 axes and spindle or 3 axes		3 axes and spindle or 4 axes	
		UE 230D		UE 240D	
		2 axes	Spindle/Axis	3 axes	Spindle/Axis
<b>Rated current <math>I_N</math></b> <i><math>I_{S6-40}</math> %<sup>1)</sup></i> <b>Maximum current</b> $I_{max}$ <sup>2)</sup> at PWM frequency	3 333 Hz	9.0 A – 18.0 A	37.2 A/27.6 A 55.2 A/– 55.2 A/55.2 A	9.0 A – 18.0 A	37.2 A/27.6 A 55.2 A/– 55.2 A/55.2 A
	4 000 Hz	8.3 A – 16.5 A	34.1 A/25.3 A 50.6 A/– 50.6 A/50.6 A	8.3 A – 16.5 A	34.1 A/25.3 A 50.6 A/– 50.6 A/50.6 A
	<b>5 000 Hz</b>	<b>7.5 A</b> – <b>15.0 A</b>	<b>31.0 A/23.0 A</b> <b>46.0 A/–</b> <b>46.0 A/46.0 A</b>	<b>7.5 A</b> – <b>15.0 A</b>	<b>31.0 A/23.0 A</b> <b>46.0 A/–</b> <b>46.0 A/46.0 A</b>
	6 666 Hz	6.3 A – 12.6 A	26.0 A/19.3 A 38.6 A/– 38.6 A/38.6 A	6.3 A – 12.6 A	26.0 A/19.3 A 38.6 A/– 38.6 A/38.6 A
	8 000 Hz	5.5 A – 11.0 A	22.6 A/16.8 A 33.6 A/– 33.6 A/33.6 A	5.5 A – 11.0 A	22.6 A/16.8 A 33.6 A/– 33.6 A/33.6 A
	10 000 Hz	4.6 A – 9.2 A	18.9 A/14.0 A 28.0 A/– 28.0 A/28.0 A	4.6 A – 9.2 A	18.9 A/14.0 A 28.0 A/– 28.0 A/28.0 A
	<b>Supply voltage</b>	3AC 400 V ( $\pm 10$ %); 50 Hz or 3AC 480 V (+6 %/–10 %); 60 Hz		3AC 400 V ( $\pm 10$ %); 50 Hz or 3AC 480 V (+6 %/–10 %); 60 Hz	
<b>Rated power</b> of DC link	<b>22 kW</b>		<b>22 kW</b>		
<b>Peak power</b> <sup>3)</sup> of DC link	30 kW / 45 kW		30 kW / 45 kW		
<b>Power loss</b> <sup>4)</sup> at $I_N$	≈ 520 W		≈ 590 W		
<b>DC-link voltage</b>	DC 565 V		DC 565 V		
<b>Integral braking resistor</b> <sup>5)</sup>	–		–		
<b>Module width</b>	200 mm		200 mm		
<b>Mass</b>	≈ 23 kg		≈ 23 kg		
<b>Functional safety</b>	✓		✓		
<b>ID</b>	733425-xx		733426-xx		

**Additional components for non-regenerative compact inverters** (see *Accessories for inverters*)

<b>Braking resistor</b>	PW 210	PW 210
<b>Surge protector</b>	VAL-MS 230/FM	VAL-MS 230/FM
<b>Voltage protection module</b> <sup>6)</sup>	SM 110	SM 110

<sup>1)</sup> Spindle: 40 % cyclic duration factor for cycle duration of 10 minutes (S6-40 %)

<sup>2)</sup> Axis: 0.2 s cyclic duration factor for cycle duration of 10 s with 70 % rated current preload

Spindle: 10 s cyclic duration factor for cycle duration of 60 s with 70 % rated current preload

<sup>3)</sup> 1st value: 40 % cyclic duration factor for cycle duration of 10 minutes (S6-40 %)

2nd value: 0.2 s cyclic duration factor for cycle duration of 5 s

3 axes and spindle or 4 axes			4 axes and spindle or 5 axes		
<b>UE 241D</b>			<b>UE 242D</b>		
2 axes	1 axis	Spindle/Axis	3 axes	1 axis	Spindle/Axis
9.0 A – 18.0 A	28.2 A – 55.2 A	37.2 A/27.6 A 55.2 A/– 55.2 A/55.2 A	9.0 A – 18.0 A	27.6 A – 55.2 A	37.2 A/27.6 A 55.2 A/– 55.2 A/55.2 A
8.3 A – 16.5 A	26.0 A – 50.6 A	34.1 A/25.3 A 50.6 A/– 50.6 A/50.6 A	8.3 A – 16.5 A	25.3 A – 50.6 A	34.1 A/25.3 A 50.6 A/– 50.6 A/50.6 A
<b>7.5 A</b> – <b>15.0 A</b>	<b>23.0 A</b> – <b>46.0 A</b>	<b>31.0 A/23.0 A</b> <b>46.0 A/–</b> <b>46.0 A/46.0 A</b>	<b>7.5 A</b> – <b>15.0 A</b>	<b>23.0 A</b> – <b>46.0 A</b>	<b>31.0 A/23.0 A</b> <b>46.0 A/–</b> <b>46.0 A/46.0 A</b>
6.3 A – 12.6 A	19.3 A – 38.6 A	26.0 A/19.3 A 38.6 A/– 38.6 A/38.6 A	6.3 A – 12.6 A	19.3 A – 38.6 A	26.0 A/19.3 A 38.6 A/– 38.6 A/38.6 A
5.5 A – 11.0 A	16.7 A – 33.6 A	22.6 A/16.8 A 33.6 A/– 33.6 A/33.6 A	5.5 A – 11.0 A	16.8 A – 33.6 A	22.6 A/16.8 A 33.6 A/– 33.6 A/33.6 A
4.6 A – 9.2 A	14.1 A – 28.0 A	18.9 A/14.0 A 28.0 A/– 28.0 A/28.0 A	4.6 A – 9.2 A	14.0 A – 28.0 A	18.9 A/14.0 A 28.0 A/– 28.0 A/28.0 A
3AC 400 V (±10 %); 50 Hz or 3AC 480 V (+6 %/–10 %); 60 Hz			3AC 400 V (±10 %); 50 Hz or 3AC 480 V (+6 %/–10 %); 60 Hz		
<b>22 kW</b>			<b>22 kW</b>		
30 kW / 45 kW			30 kW / 45 kW		
≈ 770 W			≈ 770 W		
DC 565 V			DC 565 V		
–			–		
200 mm			200 mm		
≈ 23 kg			≈ 23 kg		
✓			✓		
733427-xx			733428-xx		
PW 210			PW 210		
VAL-MS 230/FM			VAL-MS 230/FM		
SM 110			SM 110		

<sup>4)</sup> Power loss during idle running: approx. 10 % of the power loss at rated current

<sup>5)</sup> Only for direct drives with the use of an additional UM 1xxD

<sup>6)</sup> Only for synchronous or torque motors with field weakening

# Compact inverters

## Non-regenerative, integrated controller unit

**UEC 11x** The UEC 11x compact inverters not only include the inverter, but also a controller with PLC inputs/outputs and an integrated braking resistor. They offer a complete solution for machines with a limited number of axes and low power demands.

- Controllers
- Position controller, speed controller, current controller
  - HSCI interface
  - Interfaces to the speed and position encoders
- Inverters
- Power electronics
  - Connections for axis motors and spindle motor
  - Braking resistor
  - Connections for motor holding brakes
  - Additional DC-link connection on the front panel (for connection of a PSL 130)
- System PL
- Interfaces for one workpiece touch probe and one tool touch probe
  - Integrated PLC (expandable with PL 61xx)  
*UEC 11x:* 38 free inputs, 23 free outputs  
(7 of which can be switched off)  
*UEC 11xFS:* 38 free inputs, 28 free outputs  
(7 of which can be switched off),  
8 free FS inputs, 8 free FS outputs
  - Configuration with IOconfig PC software



**UMC 111FS** The UMC 111 is a compact inverter with integrated controller unit and PLC inputs/outputs. It is especially suitable for controlling the auxiliary axes: the UMC automatically enables the control loops required for the auxiliary axes. Further options are unnecessary.

- Controllers
- Position controller, speed controller, current controller
  - HSCI interface
  - Interfaces to the speed encoders
- Inverters
- Power electronics
  - Connections for axis motors
  - Connections for motor holding brakes
- System PL
- Interfaces for one workpiece touch probe and one tool touch probe
  - Integrated PLC (expandable with PL 61xx)  
*UMC 111FS:* 38 free inputs, 28 free outputs  
(7 of which can be switched off),  
8 free FS inputs, 8 free FS outputs
  - Configuration with IOconfig PC software

DC-link connections The UMC is supplied from an external DC link.



	UEC 111/UEC 112/UEC 113			UMC 111FS	
<b>Controllers</b>	4/5/6 digital control loops			4 digital control loops	
<b>Speed inputs</b>	4/5/6 x 1 V <sub>PP</sub> or EnDat 2.2			4 x 1 V <sub>PP</sub> or EnDat 2.2	
<b>Position inputs</b>	4/5/6 x 1 V <sub>PP</sub> or EnDat 2.2			–	
<b>Inverters</b>	2/3/4 axes	1 axis	Spindle	4 axes	
<b>Rated current I<sub>N</sub>/Maximum current I<sub>max</sub><sup>1)</sup> at PWM frequency</b>	<b>3 333 Hz</b>	<b>6.0 A/12.0 A</b>	<b>9.0 A/18.0 A</b>	<b>24.0 A/36.0 A</b>	<b>9.0 A/18.0 A</b>
	4 000 Hz	5.5 A/11.0 A	8.3 A/16.5 A	22.0 A/33.0 A	8.3 A/16.5 A
	5 000 Hz	5.0 A/10.0 A	7.5 A/15.0 A	20.0 A/30.0 A	7.5 A/15.0 A
	6 666 Hz	4.2 A/8.4 A	6.3 A/12.6 A	16.8 A/25.2 A	6.3 A/12.6 A
	8 000 Hz	3.6 A/7.3 A	5.5 A/11.0 A	14.6 A/21.9 A	5.5 A/11.0 A
	10 000 Hz	3.0 A/6.0 A	4.6 A/9.2 A	12.2 A/18.3 A	4.6 A/9.2 A
<b>Supply voltage</b>	3AC 400 V (±10 %); 50 Hz or 3AC 480 V (+6 %/–10 %); 60 Hz			DC-link voltage	
<b>Rated power</b> of DC link	<b>14 kW</b>			–	
<b>Peak power</b> <sup>2)</sup> of DC link	18 kW / 25 kW			–	
<b>Power loss</b> at I <sub>N</sub>	≈ 450 W			≈ 400 W	
<b>DC-link voltage</b>	DC 565 V			DC 565 V	
<b>Current consumption</b> 24 V PLC	–			DC 24 V / 2 A	
<b>Integral braking resistance</b> <sup>3)</sup>	2.1 kW / 27 kW			–	
<b>Power pack for HSCI components</b>	DC 24 V/3.5 A			–	
<b>Module width</b>	150 mm			150 mm	
<b>Mass</b>	≈ 14 kg			≈ 11 kg	
<b>Functional safety</b>	–	✓		✓	
<b>ID</b>	UEC 111/UMC 111 UEC 112 UEC 113	1081002-xx 1081003-xx 828471-xx	1075825-xx 1075826-xx 1038694-xx	664231-xx	
<b>Additional components</b>					
<b>Braking resistor</b>	–			PW 210	
<b>Surge protector</b>	VALMS 230/FM			VALMS 230/FM	
<b>Voltage-protection module</b>	SM 110			–	

<sup>1)</sup> Axis: 0.2 s cyclic duration factor for cycle duration of 10 s with 70 % rated current preload

Spindle: 10 s cyclic duration factor for cycle duration of 60 s with 70 % rated current preload

<sup>2)</sup> 1st value: 40 % cyclic duration factor for cycle duration of 10 minutes (S6-40 %)

2nd value: 4 s cyclic duration factor for cycle duration of 20 s

<sup>3)</sup> 1st value: Continuous power

2nd value: Peak power (1.5 % cyclic duration factor for cycle duration of 120 s)

# Modular inverters

## Power modules

### Power modules

The power modules in the system are to be arranged so that the "heavy" modules are mounted at left and the "light" modules are to the right of these.

The total power of all connected motors must not exceed the rating of the power supply unit.

The UM 1xx **D** modules feature electronic ID labels. This permits advanced **diagnostic functions**.

### Water cooling

The **UM 116DW** or **UM 117DW** water-cooled inverter components are recommended for operating powerful axis and spindle motors. Despite their great power, they are compact and only emit a small amount of heat in the electrical cabinet. The water-cooled inverter components are to be connected separately via a distributor to a closed coolant loop. The initial temperature of the coolant/water should be between 20 °C and 40 °C. Successfully tested pressure hoses from HEIDENHAIN are available as accessories. Pay attention to further information in the "Inverter Systems and Motors" Technical Manual.

### Fan cooling

Because the **UM 116D** and **UVR 170D** run with such high power, a separate fan unit is required as an accessory (see page 24). Please take this additional space requirement in the electrical cabinet into consideration (see *Overall dimensions*).



Power modules (continued on next double-page spread)		Single-axis power modules									
		UM 111D		UM 111BD		UM 112D		UM 113D		UM 114D	
		Axis	Axis	Spindle	Axis	Spindle	Axis	Spindle	Axis	Spindle	
<b>Rated current <math>I_N</math></b> <i><math>I_{S6-40\%}</math></i> <sup>1)</sup> <b>Maximum current</b> $I_{max}$ <sup>2)</sup> at PWM frequency	3 333 Hz	9.0 A – 18.0 A	17.5 A – 35.0 A	24.5 A <i>35.0 A</i> 35.0 A	29.5 A – 59.0 A	40.0 A <i>59.0 A</i> 59.0 A	47.0 A – 94.0 A	67.0 A <i>88.0 A</i> 94.0 A	70.0 A – 140.0 A	108.0 A <i>125.0 A</i> 140.0 A	
	4 000 Hz	8.3 A – 16.5 A	16.5 A – 33.0 A	22.5 A <i>33.0 A</i> 33.0 A	27.5 A – 55.0 A	37.0 A <i>55.0 A</i> 55.0 A	44.0 A – 88.0 A	62.0 A <i>82.0 A</i> 88.0 A	66.0 A – 132.0 A	99.0 A <i>116.0 A</i> 132.0 A	
	<b>5 000 Hz</b>	<b>7.5 A</b> – <b>15.0 A</b>	<b>15.0 A</b> – <b>30.0 A</b>	<b>20.0 A</b> <b>30.0 A</b> <b>30.0 A</b>	<b>25.0 A</b> – <b>50.0 A</b>	<b>34.0 A</b> <b>50.0 A</b> <b>50.0 A</b>	<b>40.0 A</b> – <b>80.0 A</b>	<b>56.0 A</b> <b>75.0 A</b> <b>80.0 A</b>	<b>60.0 A</b> – <b>120.0 A</b>	<b>90.0 A</b> <b>105.0 A</b> <b>120.0 A</b>	
	6 666 Hz	6.3 A – 12.6 A	12.5 A – 25.0 A	17.0 A <i>25.0 A</i> 25.0 A	21.0 A – 42.0 A	28.5 A <i>42.0 A</i> 42.0 A	33.5 A – 67.0 A	47.0 A <i>63.0 A</i> 67.0 A	55.0 A – 101.0 A	76.0 A <i>88.0 A</i> 101.0 A	
	8 000 Hz	5.5 A – 11.0 A	11.0 A – 22.0 A	14.5 A <i>22.0 A</i> 22.0 A	18.5 A – 37.0 A	25.0 A <i>37.0 A</i> 37.0 A	29.5 A – 59.0 A	41.0 A <i>55.0 A</i> 59.0 A	44.0 A – 88.0 A	66.0 A <i>77.0 A</i> 88.0 A	
	10 000 Hz	4.6 A – 9.2 A	9.0 A – 18.0 A	12.0 A <i>18.0 A</i> 18.0 A	15.5 A – 31.0 A	21.0 A <i>31.0 A</i> 31.0 A	24.5 A – 49.0 A	34.0 A <i>46.0 A</i> 49.0 A	37.0 A – 73.0 A	55.0 A <i>64.0 A</i> 73.0 A	
<b>Current consumption</b> <sup>3)</sup>		120 mA/70 mA		150 mA/225 mA		140 mA/180 mA		170 mA/360 mA		250 mA/500 mA	
<b>Power loss</b> <sup>4)</sup> at $I_N$		≈ 70 W		≈ 120 W ≈ 160 W		≈ 180 W ≈ 270 W		≈ 280 W ≈ 430 W		≈ 420 W ≈ 650 W	
<b>Cooling</b>		Air		Air		Air		Air		Air	
<b>Module width</b>		50 mm		50 mm		100 mm		100 mm		100 mm	
<b>Mass</b>		≈ 5.5 kg		≈ 5.5 kg		≈ 9.0 kg		≈ 9.0 kg		≈ 12.0 kg	
<b>Functional safety</b>		✓		✓		✓		✓		✓	
<b>ID</b>		667945-xx		671968-xx		731984-xx		730435-xx		671288-xx	

<sup>1)</sup> Spindle: 40 % cyclic duration factor for cycle duration of 10 minutes (S6-40 %)

<sup>2)</sup> Axis: 0.2 s cyclic duration factor for cycle duration of 10 s with 70 % rated current preload  
Spindle: 10 s cyclic duration factor for cycle duration of 60 s with 70 % rated current preload

<sup>3)</sup> For DC 15 V / DC 24 V (see limit values on page 6)

<sup>4)</sup> Power loss during idle running: approx. 10 % of the power loss at rated current

# Modular inverters

## Power modules

Power modules		Single-axis power modules							
		UM 115D		UM 116D		UM 116DW		UM 117DW	
		Axis	Spindle	Axis	Spindle	Axis	Spindle	Axis	Spindle
<b>Rated current <math>I_N</math></b> <i><math>I_{S6-40}</math></i> % <sup>1)</sup> <b>Maximum current</b> $I_{max}$ <sup>2)</sup> at PWM frequency	3 333 Hz	115.0 A – 230.0 A	150.0 A <i>180.0 A</i> 230.0 A	175.0 A – 350.0 A	250.0 A <i>275.0 A</i> 350.0 A	175.0 A – 350.0 A	250.0 A <i>275.0 A</i> 350.0 A	250.0 A – 500.0 A	350.0 A <i>400.0 A</i> 500.0 A
	4 000 Hz	106.0 A – 211.0 A	138.0 A <i>165.0 A</i> 211.0 A	165.0 A – 330.0 A	231.0 A <i>253.0 A</i> 330.0 A	165.0 A – 330.0 A	231.0 A <i>253.0 A</i> 330.0 A	236.0 A – 472.0 A	336.0 A <i>378.0 A</i> 472.0 A
	<b>5000 Hz</b>	<b>96.0 A</b> – <b>192.0 A</b>	<b>125.0 A</b> <b>150.0 A</b> <b>192.0 A</b>	<b>150.0 A</b> – <b>300.0 A</b>	<b>210.0 A</b> <b>230.0 A</b> <b>300.0 A</b>	<b>150.0 A</b> – <b>300.0 A</b>	<b>210.0 A</b> <b>230.0 A</b> <b>300.0 A</b>	<b>225.0 A</b> – <b>450.0 A</b>	<b>320.0 A</b> <b>360.0 A</b> <b>450.0 A</b>
	6 666 Hz	80.0 A – 161.0 A	105.0 A <i>126.0 A</i> 161.0 A	126.0 A – 252.0 A	176.0 A <i>193.0 A</i> 252.0 A	126.0 A – 252.0 A	176.0 A <i>193.0 A</i> 252.0 A	189.0 A – 378.0 A	269.0 A <i>302.0 A</i> 378.0 A
	8 000 Hz	70.0 A – 141.0 A	92.0 A <i>110.0 A</i> 141.0 A	110.0 A – 221.0 A	154.0 A <i>169.0 A</i> 221.0 A	110.0 A – 221.0 A	154.0 A <i>169.0 A</i> 221.0 A	164.0 A – 328.0 A	234.0 A <i>263.0 A</i> 328.0 A
	10 000 Hz	59.0 A – 117.0 A	76.0 A <i>91.0 A</i> 117.0 A	91.0 A – 183.0 A	128.0 A <i>140.0 A</i> 183.0 A	91.0 A – 183.0 A	128.0 A <i>140.0 A</i> 183.0 A	137.0 A – 275.0 A	195.0 A <i>220.0 A</i> 275.0 A
	<b>Current consumption</b> <sup>3)</sup>	360 mA/460 mA		400 mA/220 mA		400 mA/220 mA		450 mA/250 mA	
<b>Power loss</b> <sup>4)</sup> at $I_N$	≈ 610 W	≈ 870 W	≈ 1115 W	≈ 1560 W	≈ 1115 W <sup>6)</sup>	≈ 1560 W <sup>6)</sup>	≈ 1400 W <sup>6)</sup>	≈ 2200 W <sup>6)</sup>	
<b>Cooling</b>	Air		Fan unit		Water		Water		
<b>Module width</b>	150 mm		200 mm		200 mm		200 mm		
<b>Mass</b>	≈ 19.0 kg		≈ 24.0 kg		≈ 24.0 kg		≈ 24.5 kg		
<b>Functional safety</b>	✓		✓		✓		✓		
<b>ID</b>	671566-xx		667954-xx		667946-xx		689572-xx		

**Additional components for power modules** (see *Accessories for inverters*)

<b>Cooling</b>	–	Fan unit	Hose (set)	Hose (set)
----------------	---	----------	------------	------------

1) Spindle: 40 % cyclic duration factor for cycle duration of 10 minutes (S6-40 %)

2) Axis: 0.2 s cyclic duration factor for cycle duration of 10 s with 70 % rated current preload, with UM 117DW 0.15 s

Spindle: 10 s cyclic duration factor for cycle duration of 60 s with 70 % rated current preload

3) For DC 15 V / DC 24 V (see limit values on page 6)

### Double-axis power modules

	UM 121D	UM 121 BD <sup>5)</sup>		UM 122D <sup>5)</sup>	
	Axis	Axis	Spindle	Axis	Spindle
	9.0 A – 18.0 A	17.5 A – 35.0 A	24.5 A 35.0 A 35.0 A	29.5 A – 59.0 A	40.0 A 59.0 A 59.0 A
	8.3 A – 16.5 A	16.5 A – 33.0 A	22.5 A 33.0 A 33.0 A	27.5 A – 55.0 A	37.0 A 55.0 A 59.0 A
	<b>7.5 A</b> – <b>15.0 A</b>	<b>15.0 A</b> – <b>30.0 A</b>	<b>20.0 A</b> <b>30.0 A</b> <b>30.0 A</b>	<b>25.0 A</b> – <b>50.0 A</b>	<b>34.0 A</b> <b>50.0 A</b> <b>50.0 A</b>
	6.3 A – 12.6 A	12.5 A – 25.0 A	17.0 A 25.0 A 25.0 A	21.0 A – 42.0 A	28.5 A 42.0 A 42.0 A
	5.5 A – 11.0 A	11.0 A – 22.0 A	14.5 A 22.0 A 22.0 A	18.5 A – 37.0 A	25.0 A 37.0 A 37.0 A
	4.6 A – 9.2 A	9.0 A – 18.0 A	12.0 A 18.0 A 18.0 A	15.5 A – 31.0 A	21.0 A 31.0 A 31.0 A
	200 mA/140 mA	220 mA/110 mA		240 mA/360 mA	
	≈ 140 W	2x axis: 240 W 1x axis / 1x spindle: 280 W		2x axis: 360 W 1x axis / 1x spindle: 450 W	
	Air	Air		Air	
	50 mm	100 mm		100 mm	
	≈ 5.5 kg	≈ 9 kg		≈ 12.0 kg	
	✓	✓		✓	
	667838-xx	667942-xx		667633-xx	

<sup>4)</sup> Power loss during idle running: approx. 10 % of the power loss at rated current

<sup>5)</sup> With this 2-axis module, only the lower power stage can be used for controlling the spindle

<sup>6)</sup> Is dissipated via water cooling, remaining heat in electrical cabinet: ≈ 50 W

# Modular inverters

## Power supply unit

Supply unit	Regenerative			
	UVR 120D	UVR 130D	UVR 140D	UVR 150D
<b>Voltage supply</b>	3AC 400 V ( $\pm 10$ %); 50 to 60 Hz			
<b>Rated power</b> (DC link)	22 kW	30 kW	45 kW	55 kW
<b>Peak power</b> S6-40 % (DC link)	30 kW	45 kW	65 kW	80 kW
	40 kW <sup>2)</sup>	60 kW <sup>1)</sup>	80 kW <sup>2)</sup>	110 kW <sup>1)</sup>
<b>Power loss</b>	$\approx 300$ W	$\approx 370$ W	$\approx 570$ W	$\approx 640$ W
<b>DC-link voltage</b>	DC 650 V	DC 650 V	DC 650 V	DC 650 V
<b>Current consumption</b> 15 V/24 V	170 mA/310 mA	200 mA/400 mA	250 mA/310 mA	300 mA/540 mA
<b>Integrated 24 V power supply unit</b> <sup>7)</sup>	24 V NC/400 W	24 V NC/400 W	24 V NC/400 W	24 V NC/400 W
<b>Cooling</b>	Air	Air	Air	Air
<b>Module width</b>	150 mm	150 mm	200 mm	200 mm
<b>Mass</b>	$\approx 12$ kg	$\approx 12.5$ kg	$\approx 20.0$ kg	$\approx 20.0$ kg
<b>Functional safety</b>	✓	✓	✓	✓
<b>ID</b>	1095625-xx	1095626-xx	1084190-xx	1080611-xx

**Additional components for supply unit** (see *Accessories for inverters*)

<b>Commutating reactor</b>	KDR 120	KDR 130 C	KDR 140	KDR 150
<b>Line filter</b>	EPCOS 35A	EPCOS 80A	EPCOS 80A	EPCOS 80A
<b>Braking resistor</b>	UP 110	UP 110	UP 110	UP 110
<b>DC-link filter</b> <sup>3)</sup>	ZKF 110 or ZKF 120 or ZKF 130	ZKF 110 or ZKF 120 or ZKF 130	ZKF 110 or ZKF 120 or ZKF 130	ZKF 110 or ZKF 120 or ZKF 130
<b>Surge protector</b>	VAL-MS 230/FM	VAL-MS 230/FM	VAL-MS 230/FM	VAL-MS 230/FM
<b>Voltage protection module</b> <sup>4)</sup>	SM 1xx	SM 1xx	SM 1xx	SM 1xx
<b>Cooling</b>	–	–	–	–

<sup>1)</sup> 0.2 s cyclic duration factor for cycle duration of 5 s

<sup>2)</sup> 4 s cyclic duration factor for cycle duration of 20 s

<sup>3)</sup> Only for direct drives

<sup>4)</sup> Only for synchronous or torque motors with field weakening

<sup>5)</sup> Is dissipated via water cooling, remaining heat in electrical cabinet:  $\approx 100$  W

<sup>6)</sup> For NRTL approval 62 kW

<sup>7)</sup> In addition to the HSCI/PLC components, the power requirements of the connected inverters, encoders, and controller units must also be considered (also refer to the *Inverter Systems and Motors* Technical Manual)

	<b>Regenerative</b>				<b>Non-regenerative</b>
	<b>UVR 160D</b>	<b>UVR 160DW</b>	<b>UVR 170D</b>	<b>UVR 170DW</b>	<b>UV 130D</b>
	3AC 400 V (±10 %); 50 to 60 Hz				3AC 400 V (±10 %); 50 to 60 Hz
	80 kW <sup>6)</sup>	80 kW <sup>6)</sup>	125 kW	125 kW	30 kW
	110 kW	110 kW	180 kW	180 kW	45 kW
	160 kW <sup>2)</sup>	160 kW <sup>2)</sup>	250 kW <sup>2)</sup>	250 kW <sup>2)</sup>	60 kW <sup>2)</sup>
	≈ 930 W	≈ 930 W <sup>5)</sup>	≈ 1400 W	≈ 1400 W <sup>5)</sup>	≈ 200 W
	DC 650 V	DC 650 V	DC 650 V	DC 650 V	DC 565 V
	350 mA/1.1 A	350 mA/300 mA	450 mA/200 mA	450 mA/200 mA	100 mA/200 mA
	24 V NC/400 W	24 V NC/400 W	24 V NC, 24 V PLC/700 W	24 V NC, 24 V PLC/700 W	24 V NC, 24 V PLC/700 W
	Air	Water	Fan unit	Water	Air
	250 mm	200 mm	370 mm	250 mm	150 mm
	≈ 25.0 kg	≈ 20.0 kg	≈ 35.0 kg	≈ 26.5 kg	≈ 9.8 kg
	✓	✓	✓	✓	✓
	1095627-xx	1095809-xx	807429-xx	546911-xx	824215-xx

	KDR 160	KDR 160	KDR 170	KDR 170	–
	EPCOS 120A	EPCOS 120A	EPCOS 200A	EPCOS 200A	–
	UP 110	UP 110	UP 120	UP 120	PW 210
	ZKF 110 or ZKF 120 or ZKF 130 or ZKF 140 or ZKF 150				–
	VALMS 230/FM	VALMS 230/FM	FLT-CP-3C-350	FLT-CP-3C-350	VALMS 230/FM
	SM 1xx	SM 1xx	SM 1xx	SM 1xx	SM 1xx
	–	Hose (set)	Fan unit	Hose (set)	–

# Accessories for inverter systems

## Commutating reactors

Regenerative inverter systems require a **KDR** commutating reactor. It suppresses system perturbation and serves as energy buffer for the boost converter. It is connected between the line filter and the power supply module (see *Cable overview*).

The size of the commutating reactor depends on the power supply unit used.



	Use	Rated voltage	Rated current	Power loss	Rated frequency	Degree of protection	Mass	ID
<b>KDR 120</b>	UR 2xx D UVR 120D	3AC 400 V	3 x 35 A	≈ 200 W	50 Hz/60 Hz	IP00	≈ 11 kg	344505-01
<b>KDR 130C</b>	UVR 130D	3AC 400 V	3 x 45 A	≈ 250 W	50 Hz/60 Hz	IP00	≈ 15 kg	646271-01
<b>KDR 140</b>	UVR 140D	3AC 400 V	3 x 70 A	≈ 340 W	50 Hz/60 Hz	IP00	≈ 22 kg	333068-01
<b>KDR 150</b>	UVR 150D	3AC 400 V	3 x 80 A	≈ 350 W	50 Hz/60 Hz	IP00	≈ 23 kg	355253-01
<b>KDR 160</b>	UVR 160D UVR 160DW	3AC 400 V	3 x 117 A	≈ 525 W	50 Hz/60 Hz	IP00	≈ 57 kg	573265-01
<b>KDR 170</b>	UVR 170D UVR 170DW	3AC 400 V	3 x 180 A	≈ 875 W	50 Hz/60 Hz	IP00	≈ 106 kg	735563-01

## Line filters

If you are using a regenerative inverter system, you must use an **EPCOS** line filter in addition to the commutating reactor. Line filters suppress interference and ensure EMC-compatible energy recovery. A 3 x 32 µF three-phase current capacitor is integrated. The line filter must be connected between the power line and the commutating reactor (see *Cable overview*).

The size of the line filter depends on the power supply unit used.



	Use	Rated voltage	Rated current	Power loss	Rated frequency	Degree of protection	Mass	ID
<b>EPCOS 35A</b>	UR 2xx D UVR 120D	3AC 400 V	3 x 35 A	≈ 50 W	50 Hz/60 Hz	IP00	≈ 5 kg	676759-01
<b>EPCOS 80A<sup>1)</sup></b>	UVR 130D UVR 140D UVR 150D	3AC 400 V	3 x 80 A	≈ 75 W	50 Hz/60 Hz	IP00	≈ 11 kg	640908-01
<b>EPCOS 120A<sup>1)</sup></b>	UVR 160D UVR 160DW	3AC 400 V	3 x 120 A	≈ 115 W	50 Hz/60 Hz	IP20	≈ 13.5 kg	575292-01
<b>EPCOS 200A<sup>1)</sup></b>	UVR 170DW	3AC 400 V	3 x 200 A	≈ 170 W	50 Hz/60 Hz	IP20	≈ 20.0 kg	735542-01

<sup>1)</sup>With NRTL approval

### Braking resistor

During braking, motors feed energy back into the DC-link. The **PW 210** braking resistor converts this energy to heat. The braking resistor must be mounted outside the electrical cabinet to allow the heat to dissipate. The PW 210 has no fan, and heat is removed through radiation.

When the non-regenerative inverter systems UE 230D, UE 240D, UE 241 D, UE 242D and UV 130D are installed, the PW 210 braking resistor is required.

The PW 210 can also be used as an alternative to the integrated braking resistor in the UE 21x D.

Up to two PW 210 can be connected in parallel to the UE 230D and UE 24xD compact inverters.

No more than one PW 210 can be connected to the UE 21x D and UEC 11x.



PW 210

	Spindle power	Recommended braking resistor	Continuous power	Peak power*	Resistance	Degree of protection	Mass	ID
<b>PW 210</b>	Up to 15 kW	1 x PW 210	2 kW	≈ 27 kW	18 ohms	IP20	≈ 5.5 kg	333081-01
	Over 15 kW	2 x PW 210 in parallel	4 kW	≈ 54 kW	9 ohms	IP20	≈ 11 kg	

\* 1.5 % cyclic duration factor for cycle duration of 120 s

### Braking resistor module

Regenerative inverters feed the braking energy back into the line power system. When the power network fails, the energy cannot be returned. This increases the DC-link voltage and results in a switch-off of the inverters. This shutdown leads to an undesired coasting of the motors. To prevent this, HEIDENHAIN recommends the use of the **UP 1x0** braking resistor module for regenerative inverters.

UP 110



	Switching voltage	Module width	Peak power (for 2 s)	Degree of protection	Mass	ID
<b>UP 110</b>	DC 740 V	50 mm	≈ 60 kW	IP20	≈ 7 kg	341516-01
<b>UP 120</b>	DC 740 V	50 mm	≈ 150 kW	IP20	≈ 9 kg	605731-01

# Accessories for inverter systems

## DC-link filter

Direct drives (linear motors, torque motors, in rare cases also synchronous spindles) used with regenerative inverter systems result in voltage peaks, which can destroy the drive. Therefore, during operation with **UVR 1xxD** and **UR 2xx** regenerative inverters, the DC-link filter **ZKF 1xx must** be used. The DC-link filter is mounted at left next to the power modules of the direct drives and the DC-link current is conducted through it.

If the commutating reactor causes oscillations in the DC-link voltage, you can use a DC-link filter to prevent these oscillations. The ZKF is to be installed between the supply unit and the power module.

The total power of the motors must not exceed the power of the filter.

### Please note:

The ZKF 110 differs from the ZKF 120 only in its maximum leakage current. The use of the **ZKF 110** must be inspected by HEIDENHAIN service technicians on-site to ensure that the leakage current is less than 1.3 A. With the **ZKF 120, ZKF 130, ZKF 140** and **ZKF 150**, this measurement is not necessary because a leakage current of 6 A is sufficient in any case.



**ZKF 110**

	Power loss	Module width	Leakage current	Power				Degree of protection	Mass	ID
				P <sub>N</sub>	P <sub>S6-40 %</sub>	P <sub>S6-20 %</sub>	P <sub>max</sub>			
<b>ZKF 110</b>	50 W	100 mm	< 1.3 A	30 kW	47 kW	67 kW	110 kW	IP20	≈ 10 kg	385764-01
<b>ZKF 120</b> <sup>1)</sup>	100 W	100 mm	< 6 A	30 kW 25 kW <sup>1)</sup>	47 kW 40 kW <sup>1)</sup>	67 kW 55 kW <sup>1)</sup>	110 kW	IP20	≈ 12 kg	391232-01
<b>ZKF 130</b> <sup>1)</sup>	200 W	100 mm	< 6 A	55 kW	80 kW	100 kW	110 kW	IP20	≈ 13 kg	531388-01
<b>ZKF 140</b> <sup>1)</sup>	250 W	100 mm	< 6 A	80 kW	110 kW	140 kW	160 kW	IP20	≈ 15 kg	597954-01
<b>ZKF 150</b>	400 W	100 mm	< 6 A	125 kW	180 kW	220 kW	250 kW	IP20	≈ 16.5 kg	1068459-01

<sup>1)</sup>With NRTL approval

## Accessories for coolant connection

The water-cooled inverter components UVR 1x0 DW and UM 11x DW must be connected to an external coolant circuit. The connecting elements can be purchased as an accessory set.

### Hose (set)

1 pressure hose, length 3 m  
1 coupling joint for connecting the pressure hose to the distributor block, M18 x 1.5

ID 584862-01

Two sets are necessary for each inverter component.

### Fan unit

Fan for UM 116D, UVR 170D  
Power supply: 3AC 400V, 50/60 Hz, 0.38/0.43 A, 240/275 W  
Mass: 3.6 kg

ID 749973-02





### Surge protector

Voltage surges on the supply network can damage power supply units and inverters. An overvoltage protector should therefore be installed in the supply path (preferably after the line filter) to limit any voltage peaks to max. 1350 V.

Surge protectors from the Phoenix Company are well suited to this task. One VAL-MS 230/FM module is required per phase, while the FLT-CP-3C-350 module protects all three phases. They are mounted on a top hat rail.

	Suited for	Nominal discharge surge current	IEC test class	EN type	Width	ID
<b>VAL-MS 230/FM</b>	All except UVR 170D(W)	20 kA	II	T2:	177 mm	827105-01 (contains 3 units)
<b>FLT-CP-3C-350</b>	UVR 170D(W)	75 kA	I and II	T1 + T2	106.9 mm	826918-01

### Voltage-protection module

If synchronous motors (e.g. synchronous spindles, torque motors) are operated with field weakening, an **SM 1xx** voltage protection module is required. In the event of a power failure, this module prevents a voltage increase at the power connections of the motors that could destroy the inverters and motors. The voltage protection module is connected between the motor and inverter. It shorts the motor phases in case of a fault.

Operation in the field weakening range must be enabled by machine parameters in the control (see the Technical Manual for your control).

The **rated current of the motor** and the **max. short-circuit current  $I_K$**  of the motor must be less than the maximum phase current of the SM.  $I_K = U_0 / (\sqrt{3} \times X_H)$  with  $X_H$  in ohms

The SM 130 features an integrated temperature switch, which (if correctly wired) prevents the drive from being switched on at temperatures above 60 °C.



**SM 110**

	Switching voltage	Max. phase current $I_{max}$	Max. braking time at $I_{max}$	Min. waiting time	Degree of protection	Mass	ID
<b>SM 110</b>	DC 830 V	3AC 63 A	10 s	5 min	IP20	≈ 2 kg	368453-01
<b>SM 130</b>	DC 830 V	3AC 300 A	10 s	10 min <sup>1)</sup>	IP20	≈ 6.5 kg	540739-02

<sup>1)</sup> Thermo switch integrated

# Accessories for inverter systems

## Capacitor modules

In case of a power failure, the danger exists that the tool and workpiece can be damaged by uncontrolled motions of the axes. The LIFTOFF function of the control is able to protect expensive workpieces and tools from being damaged. In case of a power failure, and if the LIFTOFF function is active, the control attempts to retract the tool in a defined manner using the energy remaining in the DC-link.

The capacitor modules provide support regarding the energy necessary for the LIFTOFF function. They can also be connected in parallel for increased energy demands.

The **CML 110** capacitor module serves to maintain the 24 V control voltage in case of a power failure. In this case the releases of the control system are maintained even after a power failure. The CML is installed in the electrical cabinet via a top hat rail.

If a PSL 130 is used as 24 V voltage supply, the CML 110 can be omitted. The PSL 130 maintains the 24 V control voltage through the supply via the DC link.

**CML 110**



	Supply voltage	Capacitance	Charging current	ID
<b>CML 110</b>	DC 24 V	8.3 F	≤ 2.4 A	574087-02

For direct drives, the **CMH 120** capacitor module may also be necessary to maintain the DC-link voltage in case of a power failure. The CMH 120 is mounted directly before the respective inverter module.

	DC-link voltage	Capacitance	Module width	ID
<b>CMH 120</b>	≤ DC 850 V	10.0 mF	50 mm	591116-01

**CMH 120**



**Axis-release module** The axis-release module makes it possible to switch off power modules group by group. It is not needed for controls with functional safety.

The axis-release module is screwed onto the front panel of the first power module to be controlled.  
 The axis-release signal is transmitted via a line in the unit bus from power module to power module. The axis-release module can interrupt this line so that all power modules that are connected to the axis-release module are switched off. All other power modules are switched off via X72 of the UV(R) 1x0(D).

If an axis-release module is used, two unit bus cables of the appropriate lengths are necessary.

The width of the covers for the ribbon cables for the modular inverter system is reduced by the width of the axis-release module (50 mm). A suitable cover is included with the axis-release module.

For standard cover: ID 573732-02  
 For high cover: ID 573732-03

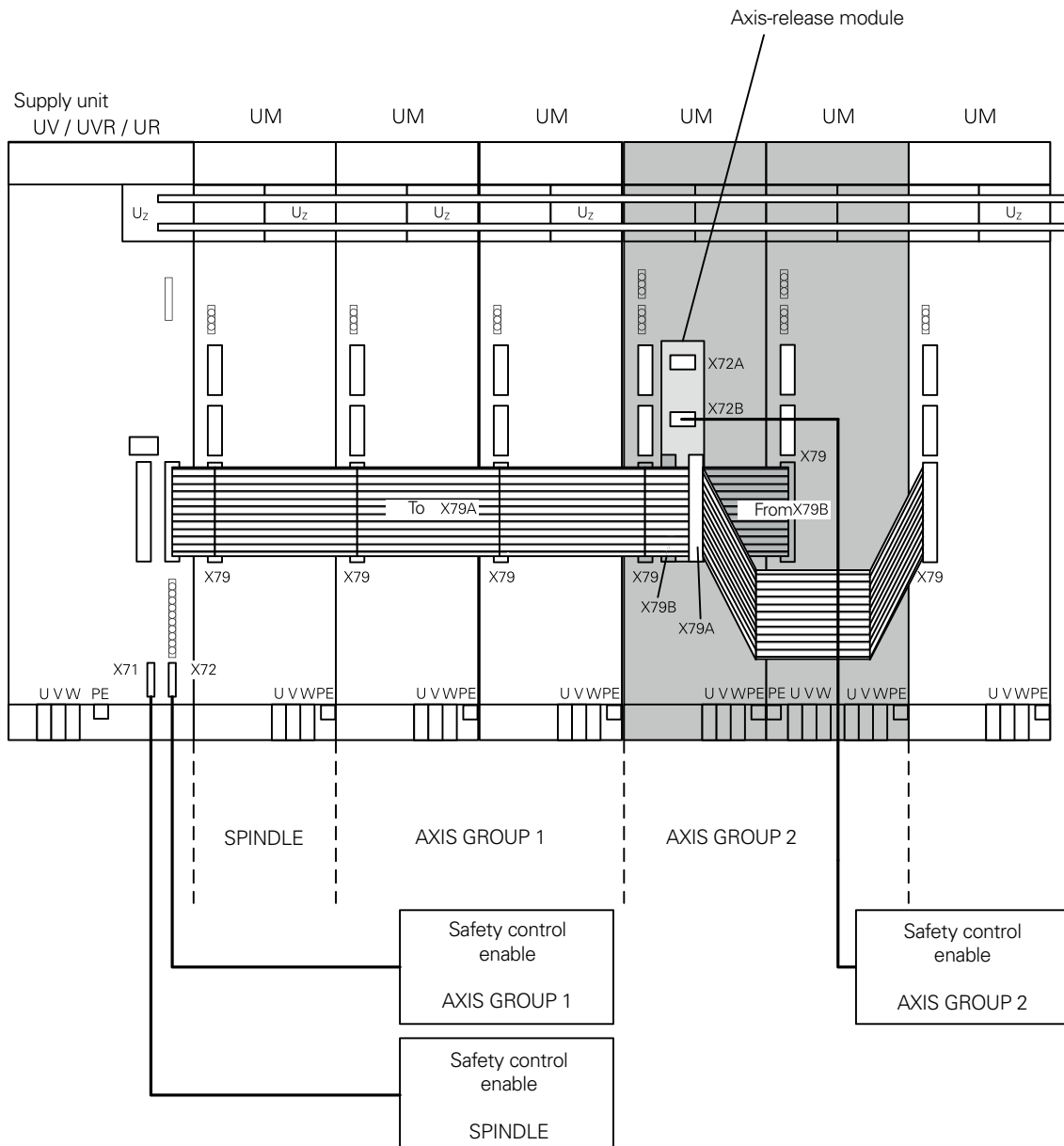

### Adapter module

In modular regenerative inverter systems an additional power supply unit may become necessary if you are using inverters or motors with a high power demand. The adapter module makes it possible to connect this power supply unit to the present inverter system. In this way one power supply unit can, for example, supply the power to a high-performance spindle and the other power supply unit can be used for the axes.

The two power supply units are coupled via the supply bus (X69a/ X69b – X69), and are then also monitored by the system.

This results in two separate supply systems whose power modules operate independently of each other, but are monitored by the control.

	Mass	ID
<b>Adapter module</b>	3 kg	352762-02



**Adapter module**

# Ribbon cables and covers

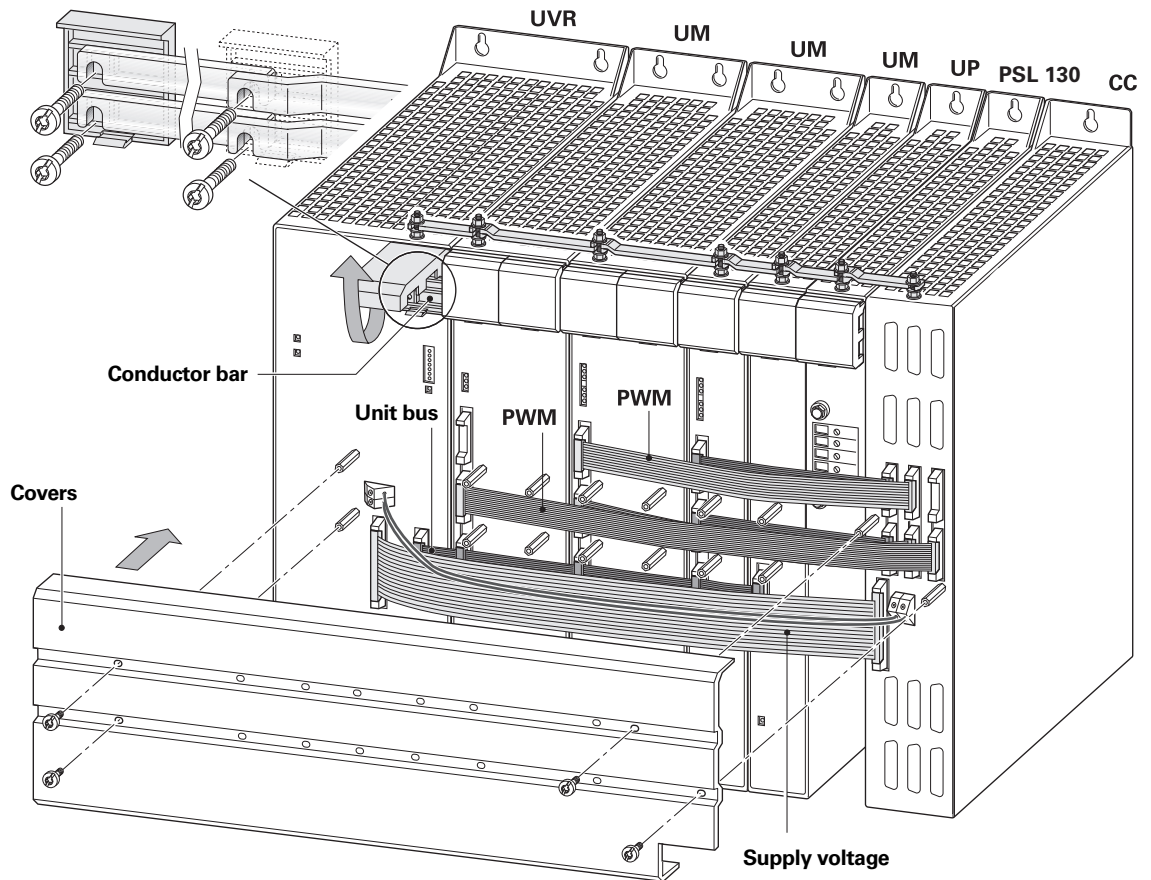

## Cover for the ribbon cables

The ribbon cables must be covered to protect them against interference. The covers are available in two versions.

- **Standard cover** (height 19 mm)
- **High cover** (height 34 mm) for machines with many drives

### Standard cover

The UV(R) power supply unit is shipped with a standard cover (329031-03) to protect the following modules.

- UV(R) 1x0 and
- UM 115 D or
- one UM 1xx D with 100 mm width and one UM 1xx D with 50 mm width

A standard cover for the CC is included in the items supplied with the CC. If you use further power modules and the UP 110 braking resistor module, you need to order suitable covers separately.

### High cover

High covers for control components must always be ordered separately. The required spacer bolts are included with the high covers. Special covers are available for the UVR supply modules and CC 61xx controller units (see table).

### Selecting the covers

- Add the widths of all modules between the UV(R) 1x0D and CC (including UP 110)
- Subtract 150 mm from this total width (cover included with the UV(R) 1x0)
- Subtract 50 mm from the remaining width for each axis-release module (cover included with the items supplied).
- Select the appropriate covers from the following table to protect the remaining width

Width	Standard cover		High cover
	Single unit	5 units in collective package	
50 mm	ID 329031-05	ID 538427-05	ID 1102784-05
100 mm	ID 329031-10	ID 538427-10	ID 1102784-10
150 mm	ID 329031-15	ID 538427-15	ID 1102784-15
200 mm	ID 329031-20	ID 538427-20	ID 1102784-20
450 mm	–	–	ID 1102784-45
150 mm for UVR	–	–	ID 1102784-44
100 mm for CC 6108 and CC 6110	–	–	ID 1102784-16
75 mm for CC 6106	–	–	ID 1102784-19

#### Accessories for ribbon cables

Plastic holding elements for the PWM cables facilitate mounting the covers. They are simply plugged onto the mounted spacer bolts, thus fixing the PWM cables. These holding elements can be used for standard covers and high covers. They can be ordered separately in a collective package containing 20 units. The items supplied with the high cover for UVR already include four holding elements.

ID 1113339-01

#### 50-pin ribbon cable for supply voltage

Connection between the CC and UV(R) 1xx power supply unit (required only once).

Length	ID
300 mm	325816-01
400 mm	325816-02
500 mm	325816-03
600 mm <sup>1)</sup>	325816-04
700 mm <sup>1)</sup>	325816-05
800 mm <sup>1)</sup>	325816-06
900 mm <sup>1)</sup>	325816-07
1000 mm <sup>1)</sup>	325816-08
1200 mm <sup>1)</sup>	325816-12
1400 mm <sup>1)</sup>	325816-14

<sup>1)</sup> For transmission lengths greater than 600 mm, the ribbon cable is led doubled to the controller unit to increase the cross section.

The use of a 5 V wire (2 x 4 mm<sup>2</sup>), in addition to the ribbon cable, is required for reliable power supply. The wire must be provided by the customer!

Selecting a cable length

**UVR:** Add 70 mm to the width of all modules between the UVR 1xx D and CC and select the next larger cable length.

**UV 130D:** Add 130 mm to the width of all modules between the UV 130D and CC and select the next larger cable length.

Module	Width
UM 111 D, UM 121 D UM 111 BD, PSL 13x	50 mm
UM 112 D, UM 122 D UM 111 BD, UM 121 BD UM 113 D, UM 114 D	100 mm
UM 115 D	150 mm
UM 116 D, UM 116 DW, UM 117 DW	200 mm
UP 110, UP 120	50 mm
UV 105	50 mm

**40-pin ribbon cable for unit bus**

Connection between the UV 1x0 power supply unit and the UM 1xx power modules and, if needed, the UP 110 braking resistor module (required only once).

Length	ID
300 mm	325817-01
400 mm	325817-02
500 mm	325817-03
600 mm	325817-04
700 mm	325817-05
800 mm	325817-06
900 mm	325817-07
1000 mm	325817-08
1200 mm	325817-12
1400 mm	325817-14

Selecting a cable length

**UVR:** Add the width of all modules between the UVR 1xx D and the controller unit (including the UP 110) and choose the next larger cable length from the above table.

**UV 130D:** Add 80 mm to the width of all modules between the UV 130 D and CC and select the next larger cable length.

**Axis-release module:** Two unit bus cables are required. The lengths depend on the position of the axis-release module.

**20-pin ribbon cable for PWM signals**

Connection between the controller unit and a UM 1xx D power module (one cable per drive)

Length	ID
100 mm	250479-07
200 mm	250479-08
300 mm	250479-09
400 mm	250479-10
500 mm	250479-11
600 mm	250479-12
700 mm	250479-13
800 mm	250479-14
900 mm	250479-15
1000 mm	250479-16
1200 mm	250479-20

Selecting a cable length

- See the table for distance a of the PWM input on the power module.
- Add the widths b of all modules between the respective power module and the controller unit (including UP 110 and ZFK).
- Add the distance  $c_n$  of the PWM output on the controller unit to your result (see table).
- Select the next-larger cable length from the above table.

Power module	Distance a	Module width b
MS 110, MS 111 mounting cases UM 111 BD, UM 111 D, UM 121 D	≈ 40 mm	50 mm
UM 121 BD	≈ 85 mm	100 mm
UM 112 D, UM 113 D, UM 114 D, UM 122 D	≈ 90 mm	100 mm
UM 115 D	≈ 140 mm	150 mm
UM 116 D(W), UM 117 DW	≈ 190 mm	200 mm

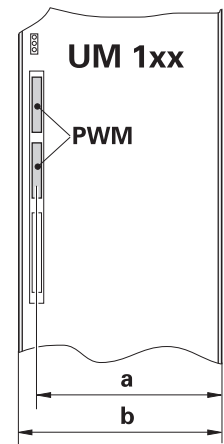



Distance  $c_n$

CC 61xx	Distance in mm				
	$c_1$	$c_2$	$c_3$	$c_4$	$c_5$
CC 6106	23	39	56	–	–
CC 6108	23	39	56	73	–
CC 6110	23	39	56	73	92

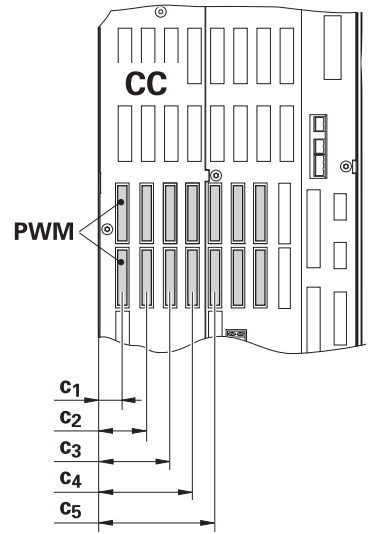

Example

Calculating the distance  $l$  between the connectors on the UM 115 D and the controller unit:

$$\begin{aligned}
 l &= a + b_1 + b_2 + b_3 + b_4 + c_3 \\
 &= (140 + 100 + 100 + 50 + 50 + 56) \text{ mm} \\
 &= 496 \text{ mm}
 \end{aligned}$$

A 500 mm cable (the next larger length) is used to connect the PWM.

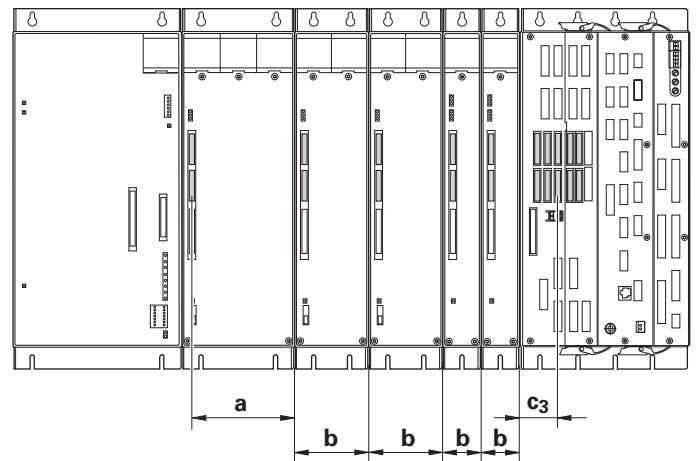

# Double-row configuration

Sometimes limited space prevents the control and inverter system(s) from being mounted in the same row in the electrical cabinet, meaning that they must be mounted in separate rows.

## Mounting cases for multi-row configuration

HEIDENHAIN offers special MS 1xx mounting cases that can be used to establish an electrical connection (immune to noise) between the components of the inverter system. These mounting cases are installed immediately to the right of the UV (R) power supply unit or at the start of the second row.

### MS 110

The ribbon cables (unit bus, PWM lines, supply bus) in the MS 110 mounting cases are connected with shielded round cables of the appropriate lengths and at the other end, these are connected again with ribbon cables.

### MS 111

The MS 111 mounting case also offers the possibility of feeding DC 24 V from an external power supply unit. In addition, the MS 111 features two connectors for the unit bus, which permits use in single-row and double-row configurations. This is necessary in rare cases when the DC 24 V voltage from the UVR 1xx D power supply unit is not sufficient to supply the module fans with power. For the current consumption of the fans, refer to the specifications of the power supply units and inverter systems. Based on these values you can calculate whether feeding in the additional DC 24 V is necessary. The sum of the currents must not exceed the maximum current provided by the UV(R).

### Setup without additional DC 24 V feeding

In most cases it is not necessary to supply the DC 24 V. For multi-row setup, **two MS 110 units** are used.

### Setup with additional DC 24 V feeding

If feeding of the additional DC 24 V is necessary, one **MS 110** and one **MS 111** are required. The MS 110 is placed next to the UV (R) supply unit and the MS 111 in the other row.

#### Please note:

When using the MS 111, external DC 24 V voltage supply is mandatory in order to supply the fans with power. Otherwise, the inverters will overheat and shut down with the message "TEMP>>"!



## Components/cables for multi-row configuration

<b>MS 110 mounting case</b>	658132-01
<b>MS 111 mounting case</b>	673685-02
<b>Unit bus cable</b> (round, shielded) with 37-pin D-sub connector at both ends; max. length: 3 m	664023-xx
<b>PWM cable</b> (round) with ribbon connector at both ends; max. length: 5 m	664332-xx
<b>Supply bus cable</b> (round) with ribbon connector at both ends, max. length: 5 m (required only if UV(R) 1xx D is not in the same row as CC/MC)	361508-xx
<b>Wire</b> for DC link (16 mm <sup>2</sup> , shielded), max. length: 3 m	
Color: Red	655440-xx
Color: Blue	655438-xx

**Basic circuit diagrams**

Single-row arrangement—fan power supply is additional via MS 111

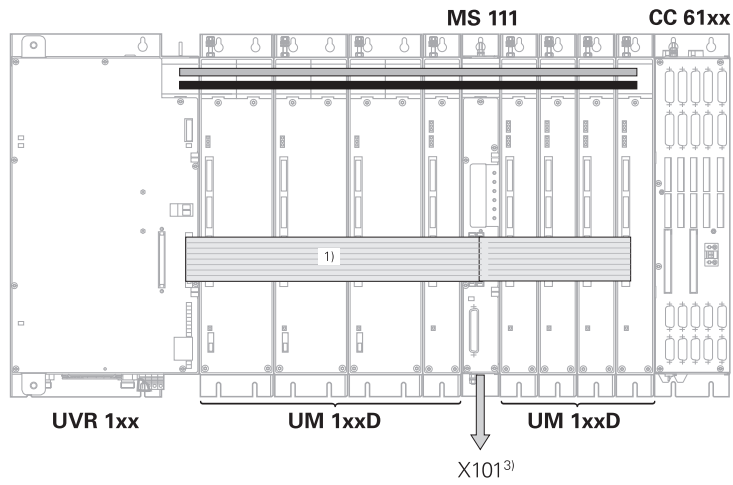

Double-row arrangement—fan power supply of the 2nd row via MS 111

The MS 110 is mounted in the lower row, right next to the supply module; the MS 110 or—if required—the MS 111 for DC 24 V feeding is mounted in the upper row.

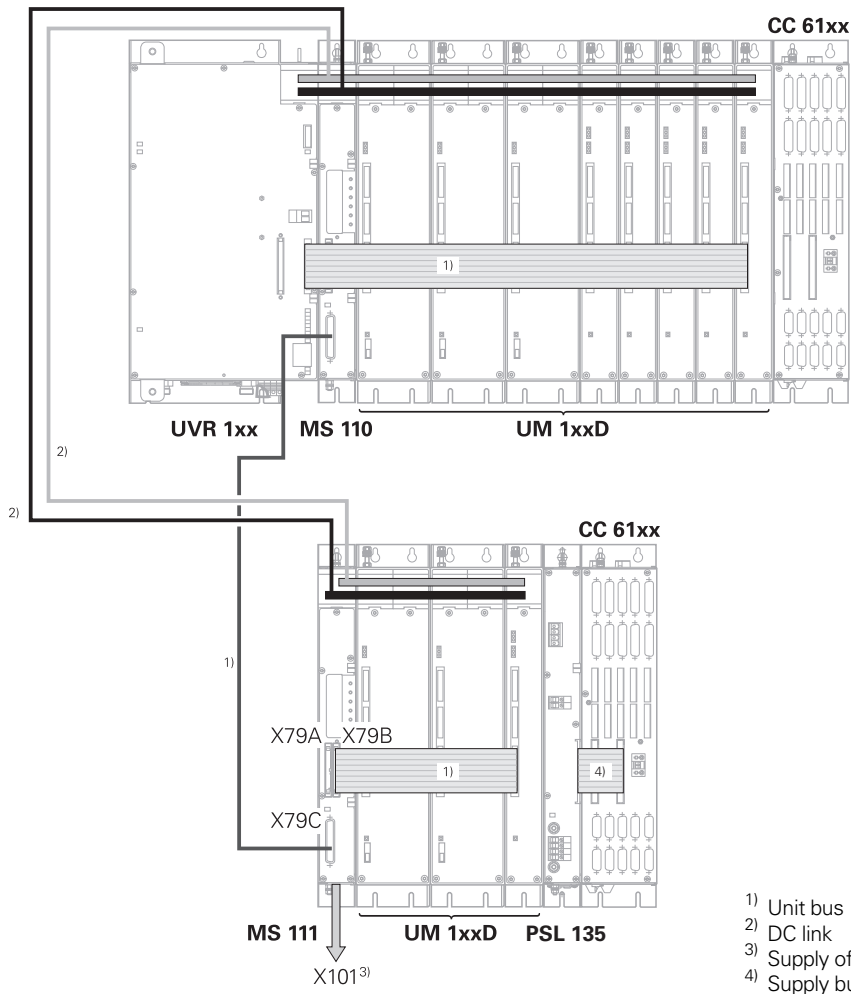

Double-row arrangement—fan power supply of the 1st row via MS 111

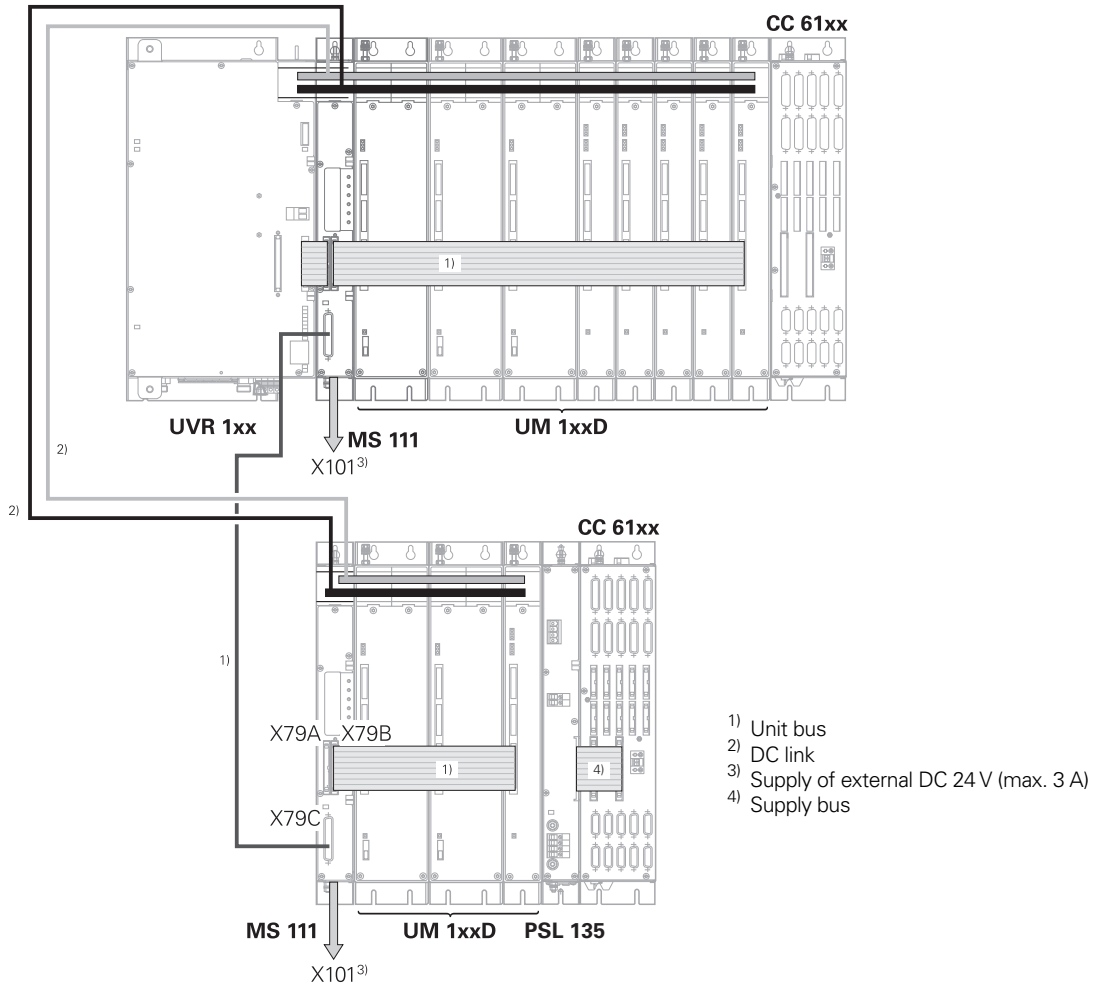

**Notes**

**Please note the following regarding the setup of multi-row systems:**

- The wires used for the DC-link connection of the power modules in the "second row" must not be longer than 3 m.
- Wires with 16 mm<sup>2</sup> cross section make a DC-link current of approx. 67 A possible. In a regenerative system, this results in approx. 35 kW of continuous power for the system connected by these wires.  
 In a non-regenerative system, the resulting maximum power is approx. 25 kW.
- Use fast-acting semiconductor fuses for protection of the UV(R) 1xx D on the primary side (see *Technical Manual for Inverter Systems and Motors*).
- The length of the unit bus ribbon cable must not exceed 1 m. If necessary, place the MS 110 or MS 111 in the "second row" in the center of the UMs.
- When calculating the length of the ribbon cables, make sure to include the module width of the MS 110 or MS 111.

**Several UV(R)  
supply modules,  
each with one CC**

All axes and spindles whose power modules are connected to a supply module via the DC link may be assigned only to those drive-control motherboards that are connected to the same supply module via the supply bus. This assignment of supply modules must not be mixed.

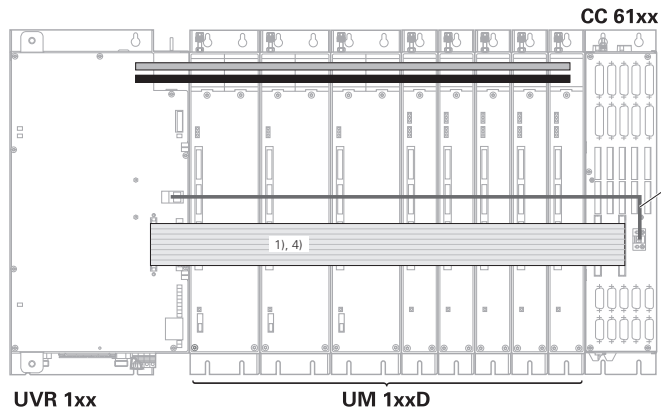
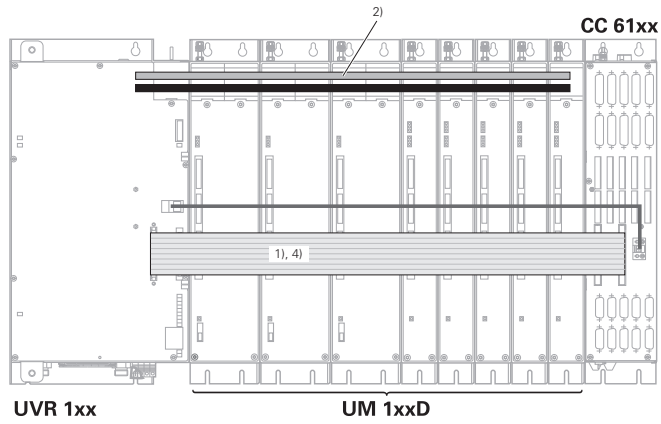

- 1) Unit bus
- 2) DC link
- 3) 5 V supply for CC
- 4) Supply bus

Single-row  
arrangement with  
two UVRs 1xxD,  
each with one  
CC 6xxx

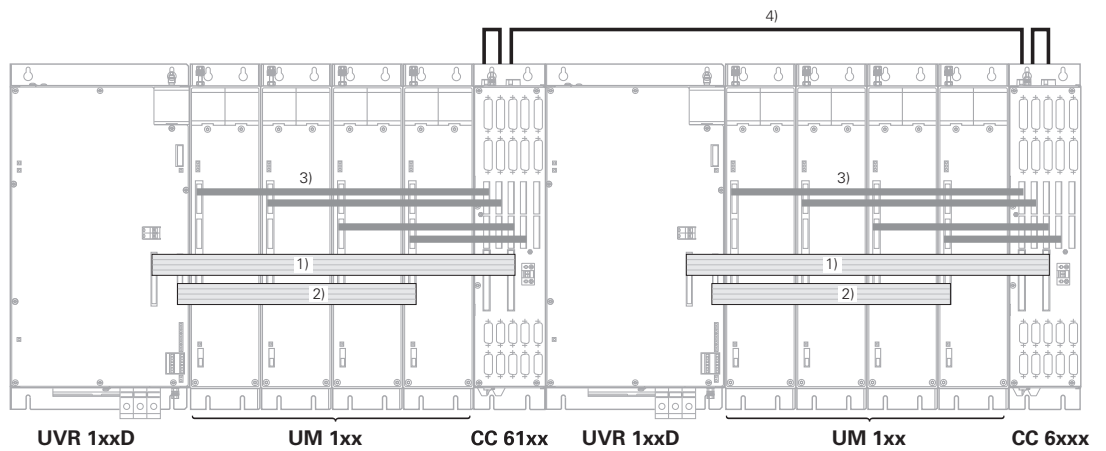

- 1) Supply bus X69
- 2) Unit bus X79
- 3) PWM cables
- 4) HSCI connection

Double-row arrangement, each row with its own UVR 1xx D and CC 6xxx

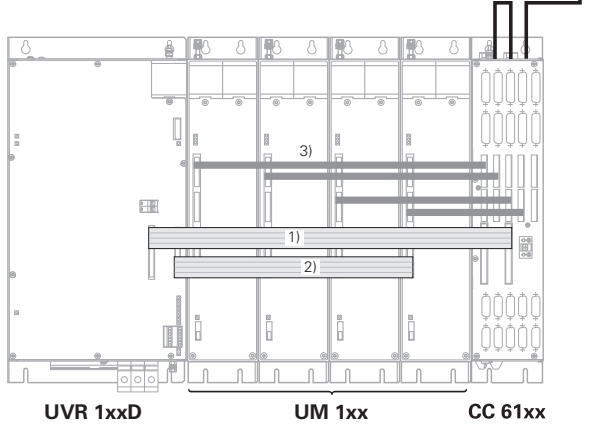
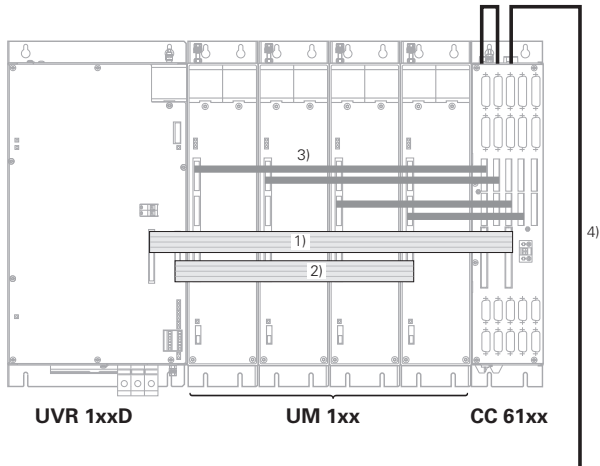

- 1) Supply bus X69
- 2) Unit bus X79
- 3) PWM cables
- 4) HSCI connection

Double-row arrangement with two UVRs and one CC 6108 or CC 6110

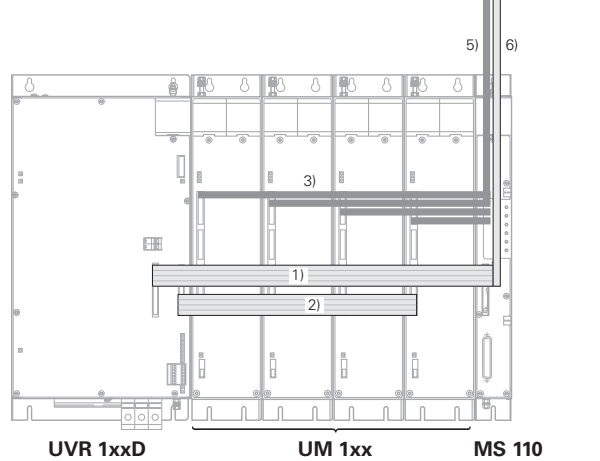
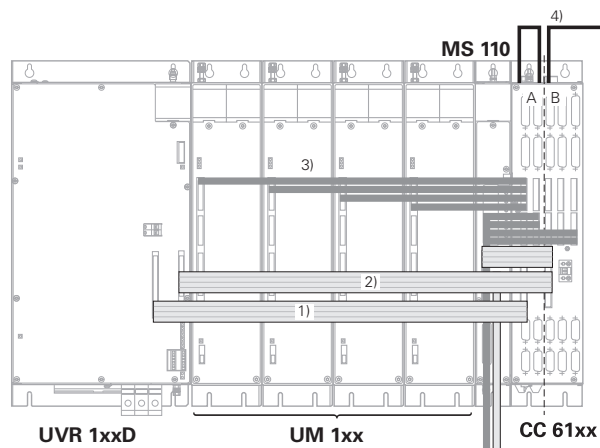

- 1) Supply bus X69
- 2) Unit bus X79
- 3) PWM cables
- 4) HSCI connection
- 5) PWM cables (round)
- 6) Supply bus cable (round)

Double-row arrangement with one UVR 1xx D and one CC 6xxx

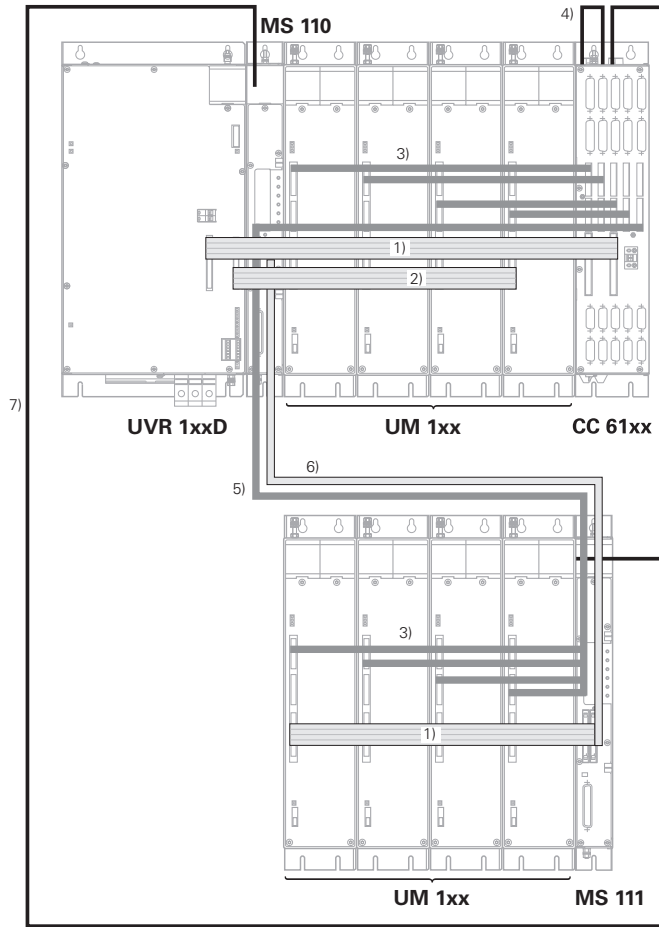

- 1) Supply bus X69
- 2) Unit bus X79
- 3) PWM cables
- 4) HSCI connection
- 5) PWM cables (round)
- 6) Unit bus cable (round, shielded)
- 7) DC link

# Cable overview

## Inverters

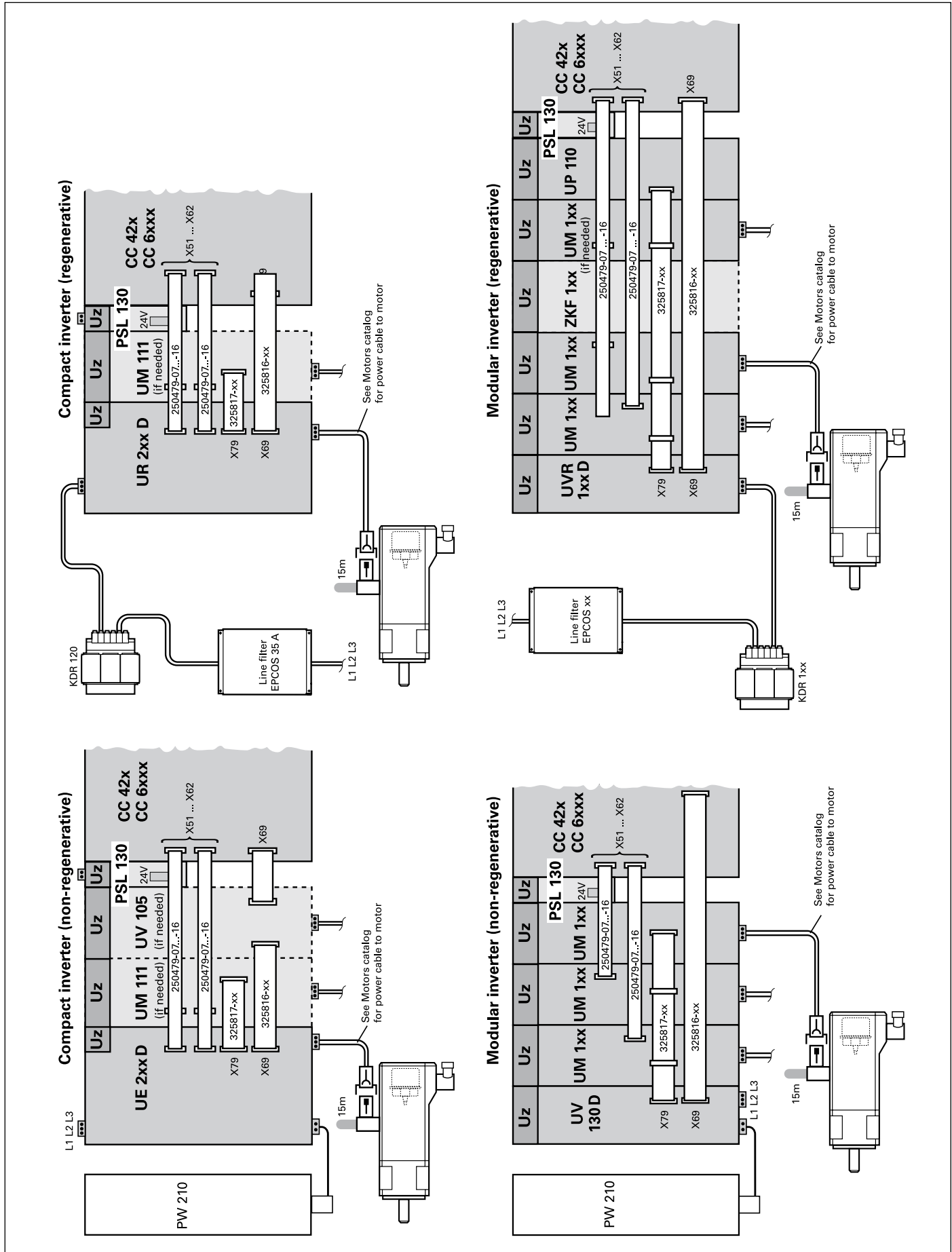



# Mounting information

**Mounting position** When mounting the control and inverter components, please observe the proper minimum clearances, space requirements, length and position of the connecting cables.

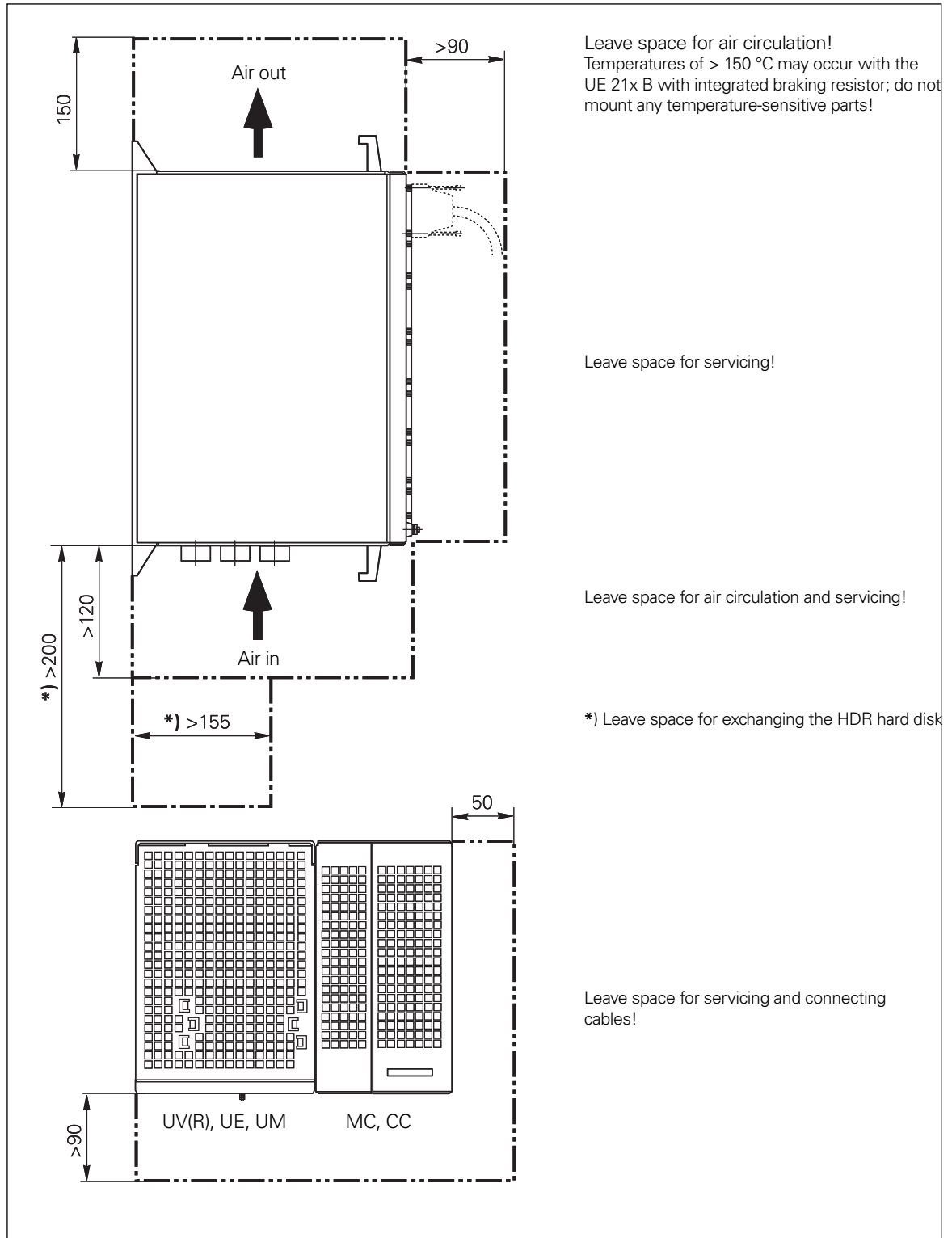

## Mounting and electrical installation

Keep the following in mind during mounting and electrical installation:

- National regulations for low-voltage installations at the operating site of the machine or components
- National regulations regarding interference and noise immunity at the operating site of the machine or components
- National regulations regarding electrical safety and operating conditions at the operating site of the machine or components
- Specifications for the installation position
- Specifications of the Technical Manual

## Degrees of protection

The following components fulfill the requirements for IP54 (dust and splash-proof protection).

- Display unit (installed)
- Keyboard unit (installed)
- Machine operating panel (installed)
- Handwheel

All electric and electronic control components must be installed in an environment (e.g. electrical cabinet, housing) that fulfills the requirements of protection class IP54 (dust and splash-proof protection) in order to fulfill the requirements of pollution degree 2. All components of the OEM operating panel must also comply with protection class IP54, just like the HEIDENHAIN operating panel components.

## Electromagnetic compatibility

Intended place of operation

The units comply with EN 50370 and EN 61800-3 Category C3, and are intended for use in industrially zoned areas.

Protect your equipment from interference by observing the rules and recommendations specified in the Technical Manual.

Likely sources of interference

Interference is mainly produced by capacitive and inductive coupling into electrical conductors or into device interfaces, caused by e.g.:

- Strong magnetic fields from transformers or electric motors
- Relays, contactors and solenoid valves
- High-frequency equipment, pulse equipment and stray magnetic fields from switch-mode power supplies
- Power lines and leads to the above equipment

Protective measures

- Keep a minimum distance of 20 cm from the MC, CC and its leads to devices that carry interference signals.
- Keep a minimum distance of 10 cm from the MC, CC and its leads to cables that carry interference signals. For cables in metallic ducting, adequate decoupling can be achieved by using a grounded separation shield.
- Shielding by means of closed metal housings.
- Use equipotential bonding lines according to the grounding plan. Please refer to the Technical Manual of your control.
- Use only genuine HEIDENHAIN cables, connectors and couplings.

## Installation elevation

The maximum installation altitude for HEIDENHAIN power modules or inverters (UVR, UV, UM, UE, UEC, UR, etc.) for direct connection to line power is 2000 m above sea level. If the HEIDENHAIN control system is connected to line power through an isolating transformer, the maximum installation altitude increases to 3000 m above sea level.

Note that performance is degraded by current derating when HEIDENHAIN power modules are installed at altitudes greater than 1000 m above sea level. To reduce this effect, you can reduce the maximum ambient temperature by 3.5 K per 500 m.

Interpolation is linear for current derating:

*1000 to 2000 m: 100 % to 84 %*

*2000 to 3000 m: 84 % to 75 %*

# Dimensions

## UR 2xx D series

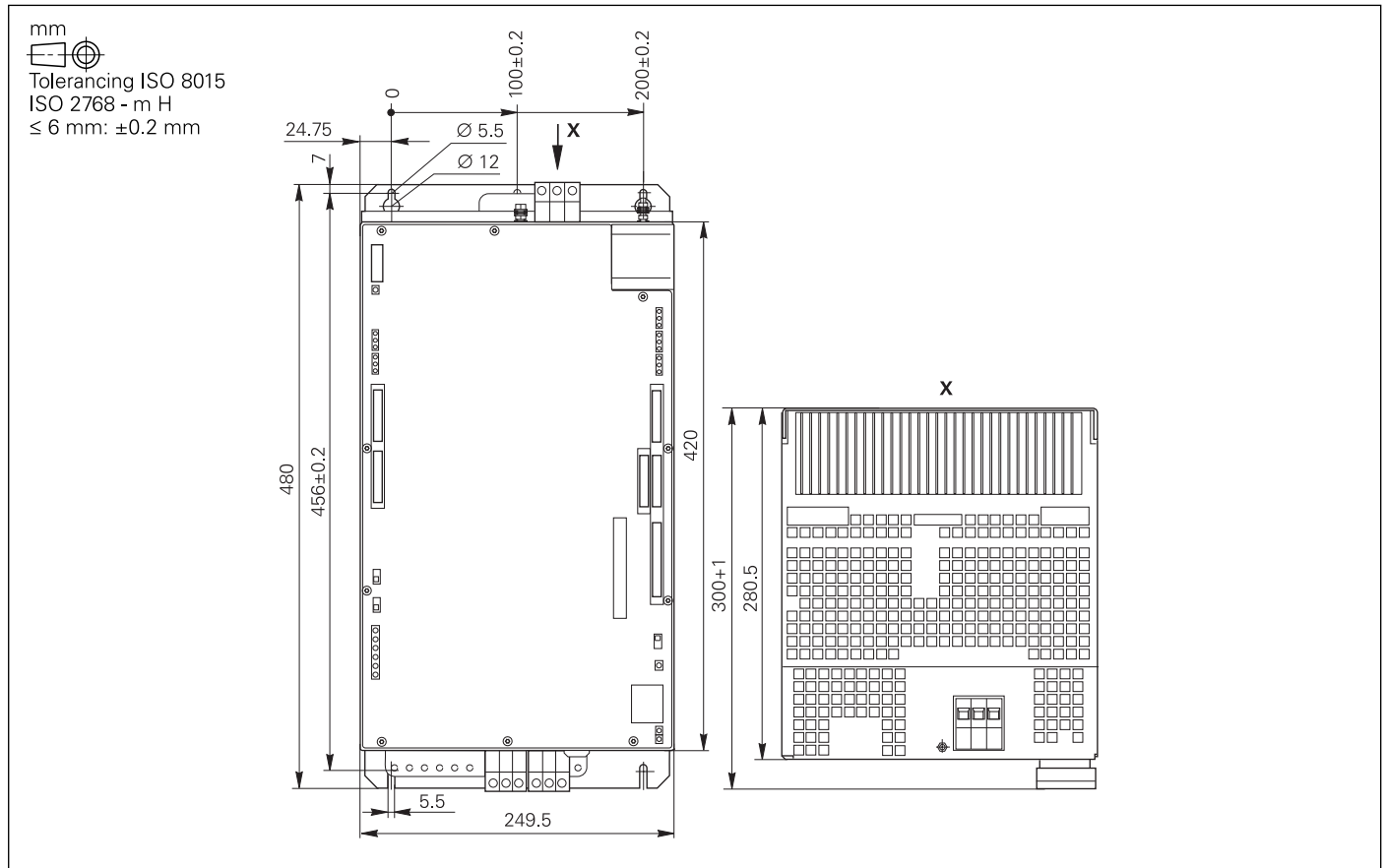

## UEC 111, UEC 112, UEC 113, UMC 111 series

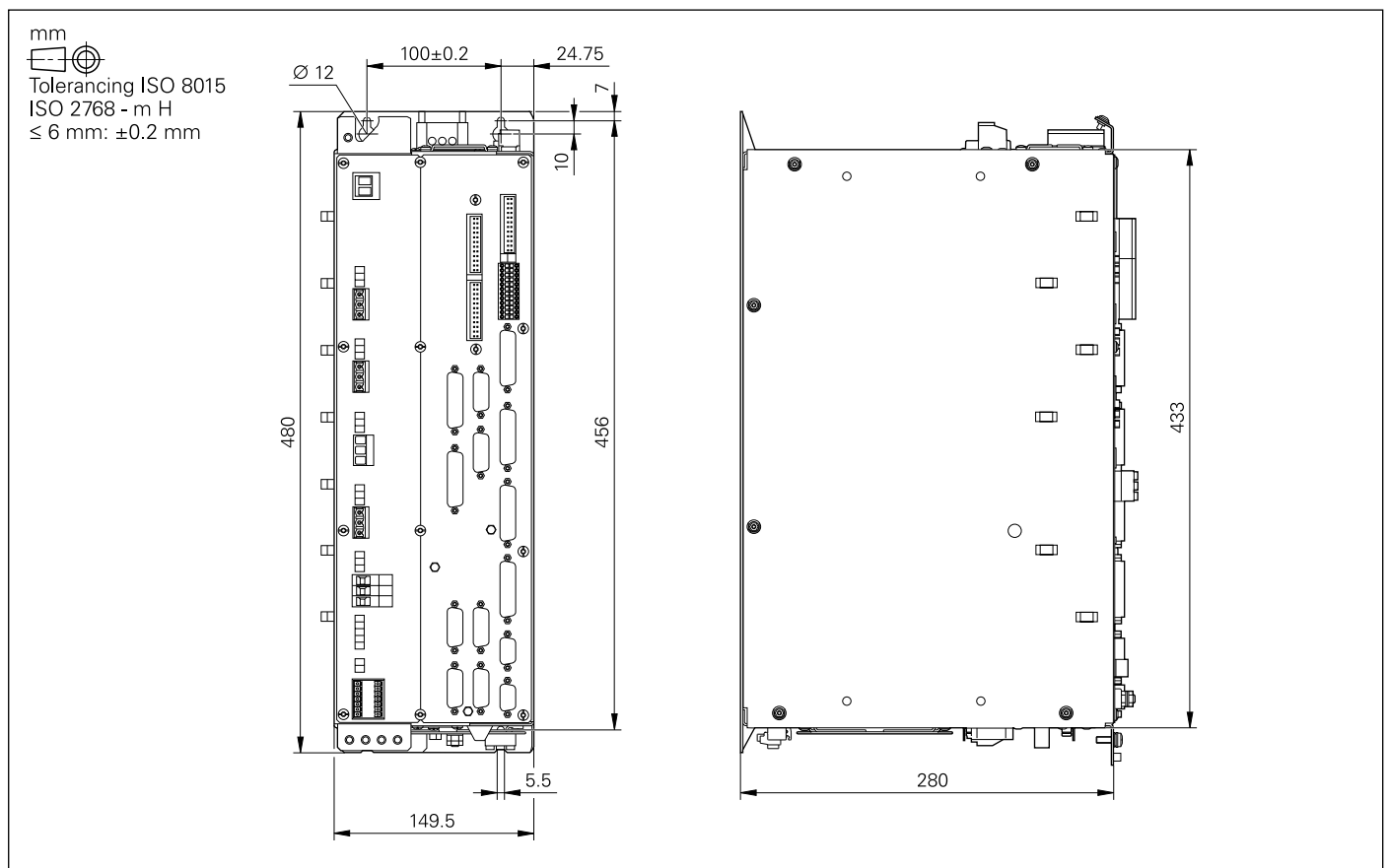

### UE 2xx D series

mm  
  
Tolerancing ISO 8015  
ISO 2768 - m H  
≤ 6 mm: ±0.2 mm

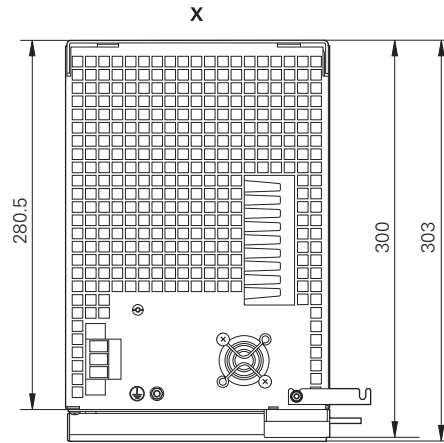
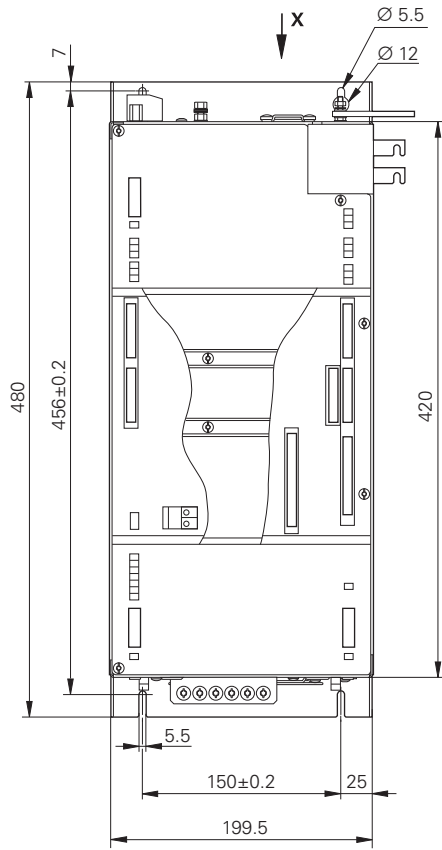

**UVR 120D, UVR 130D**

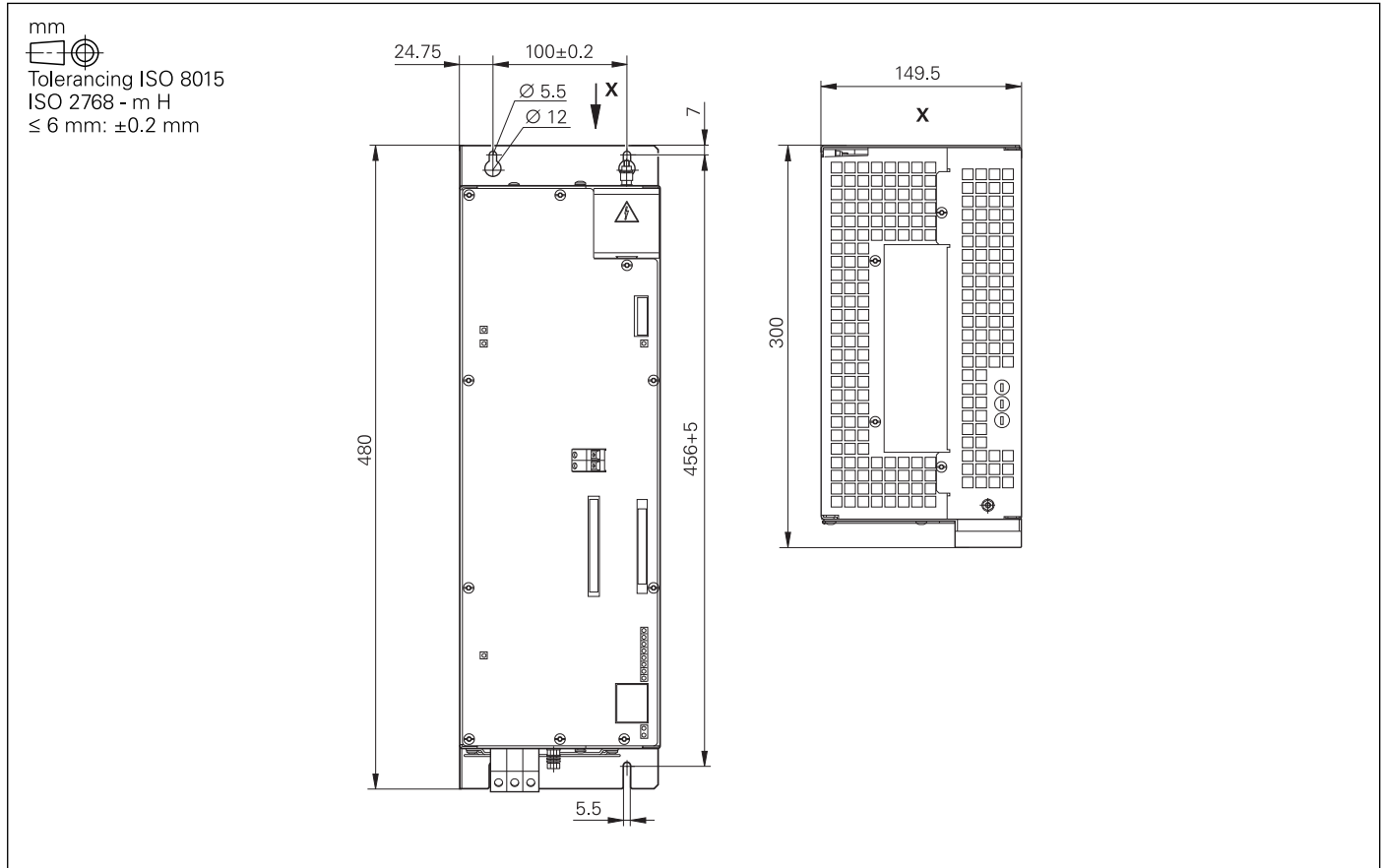

**UVR 140D, UVR 150D**

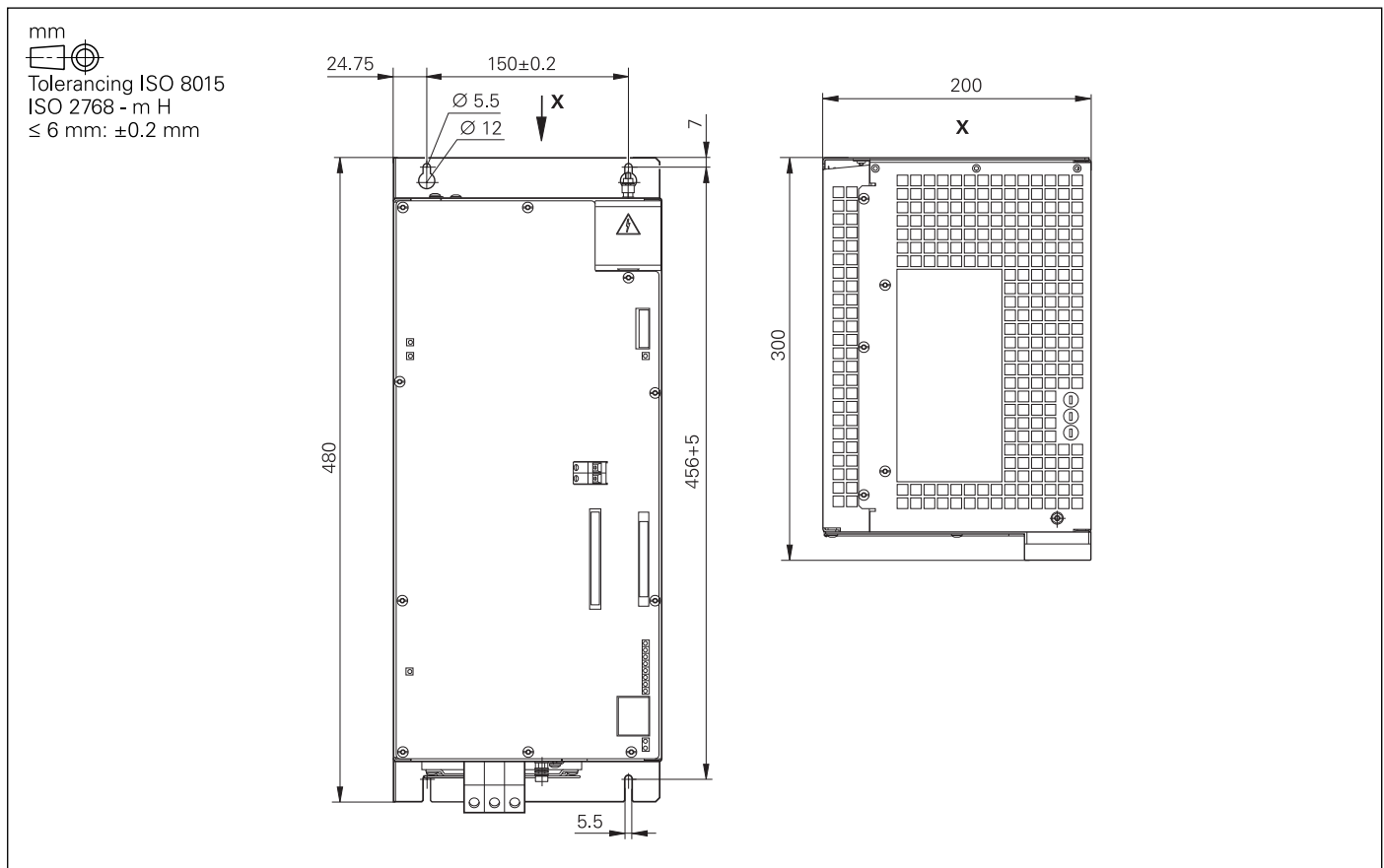

**UVR 160D**

mm  
  
 Tolerancing ISO 8015  
 ISO 2768 - m H  
 ≤ 6 mm: ±0.2 mm

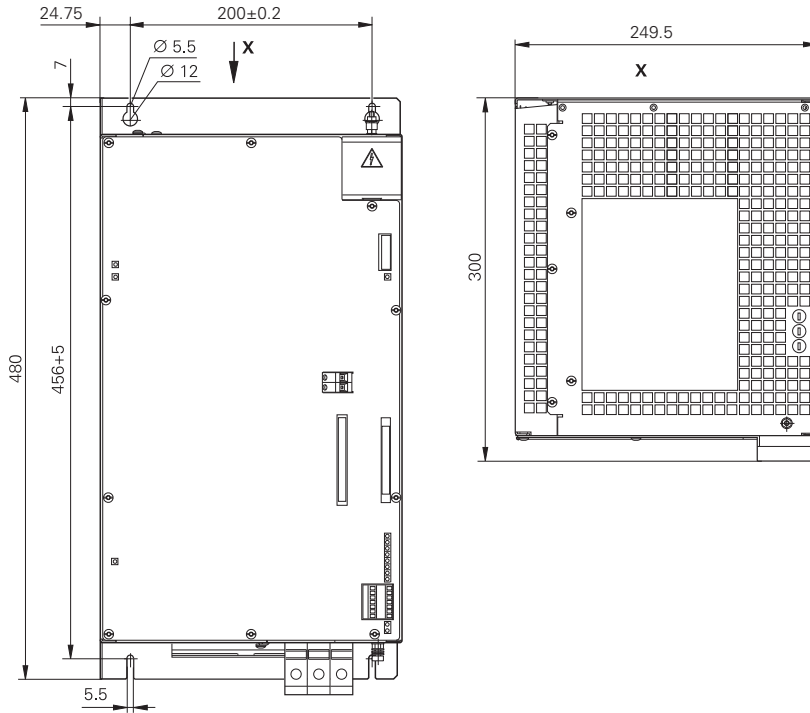

**UVR 160DW**

mm  
  
 Tolerancing ISO 8015  
 ISO 2768 - m H  
 ≤ 6 mm: ±0.2 mm

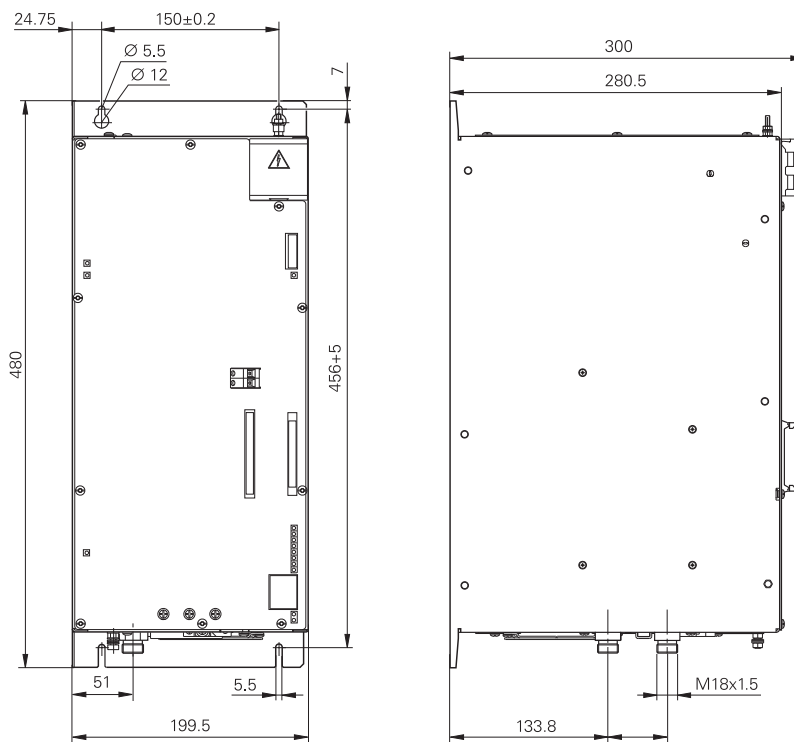

# UVR 170D

mm



Tolerancing ISO 8015  
ISO 2768 - m H  
≤ 6 mm: ±0.2 mm

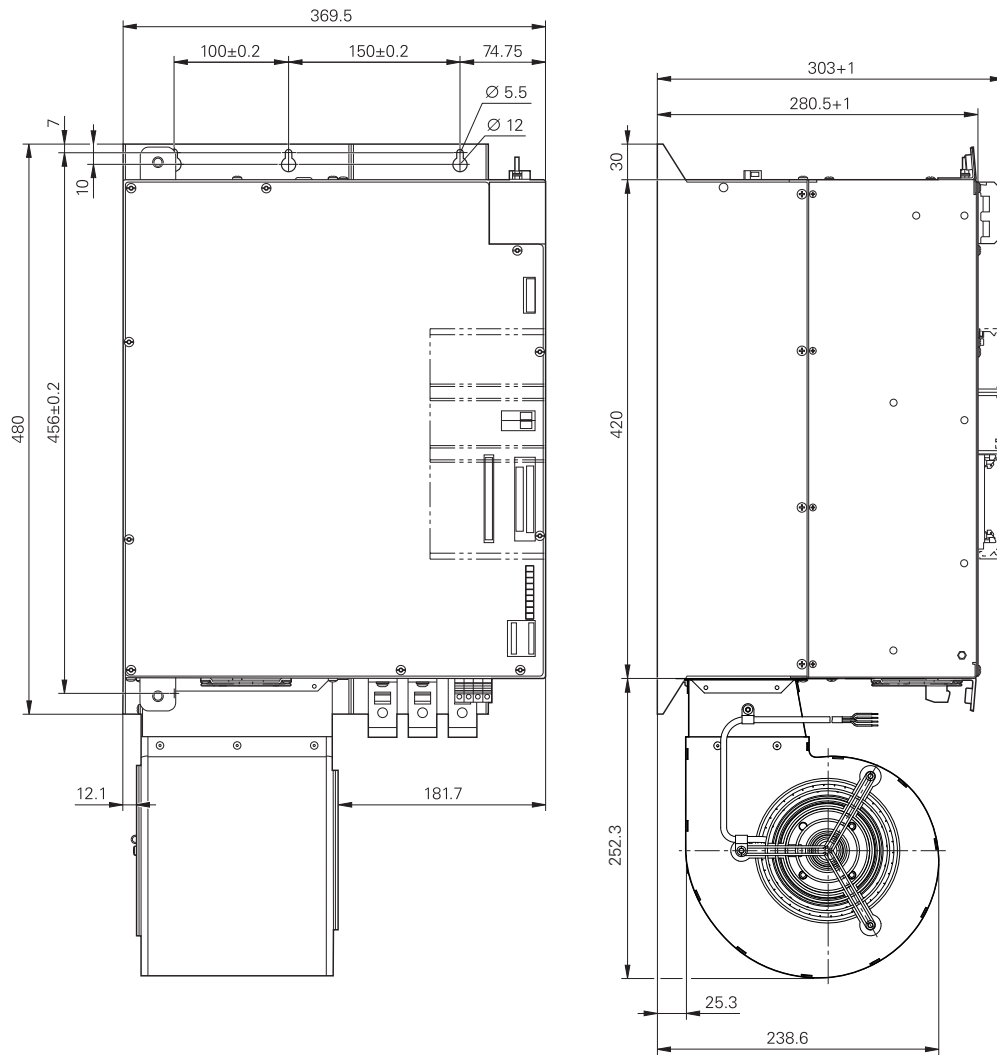

**UVR 170DW**

mm  
  
 Tolerancing ISO 8015  
 ISO 2768 - m H  
 ≤ 6 mm: ±0.2 mm

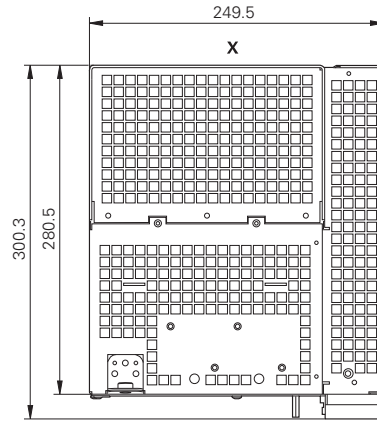
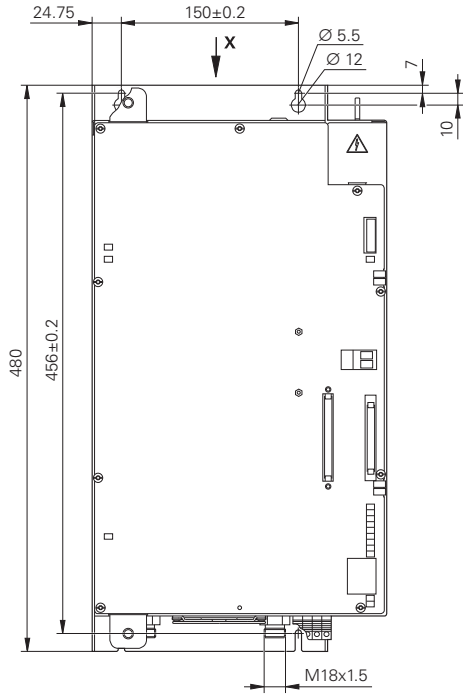

**UV 130D**

mm  
  
 Tolerancing ISO 8015  
 ISO 2768 - m H  
 ≤ 6 mm: ±0.2 mm

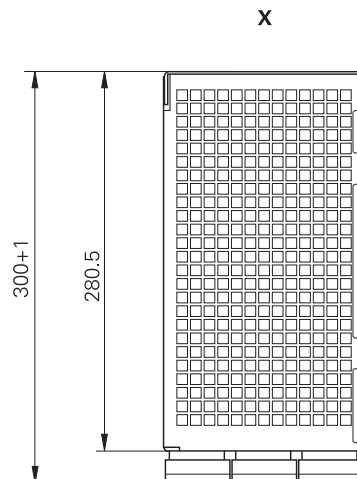
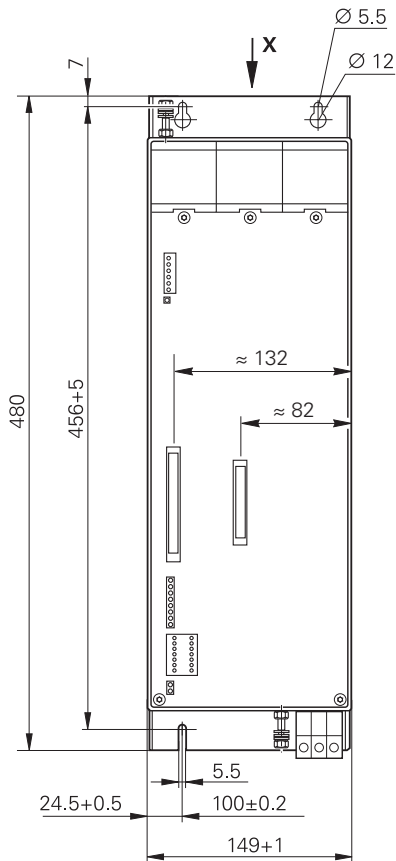



**UM 111D, UM 111BD, UM 121D**

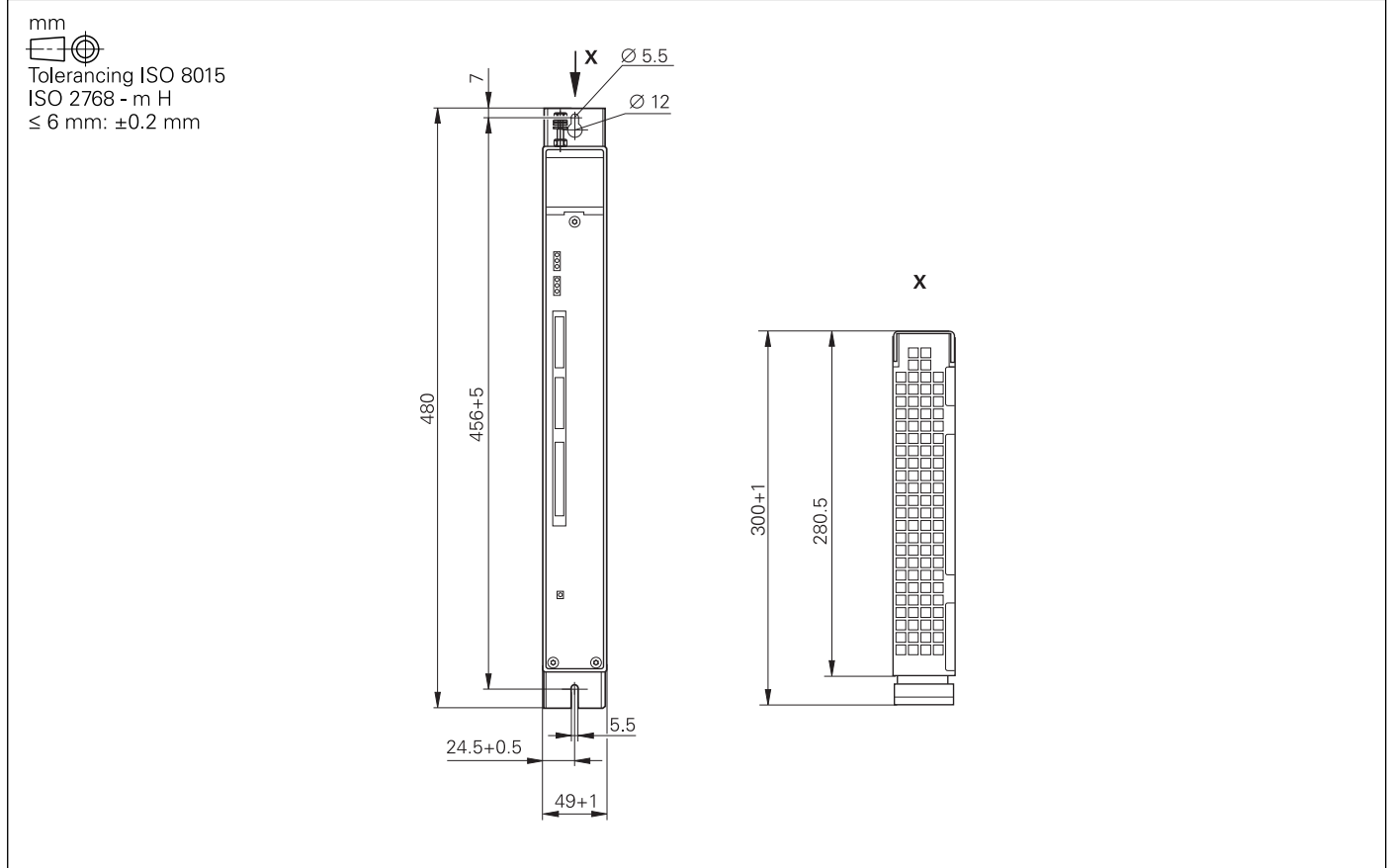

**UM 112D, UM 113D, UM 114D, UM 121BD, UM 122D**

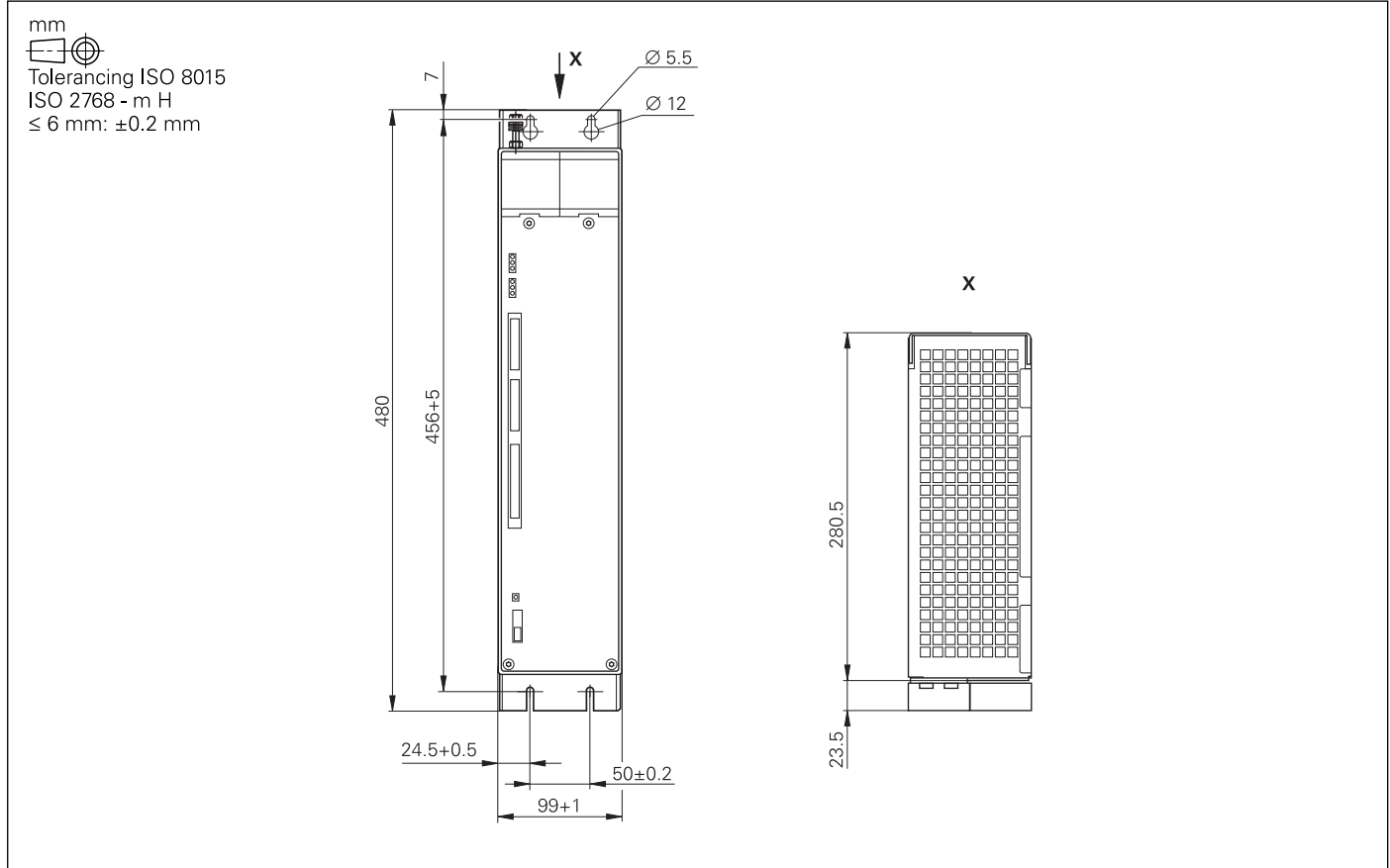

**UM 115D**

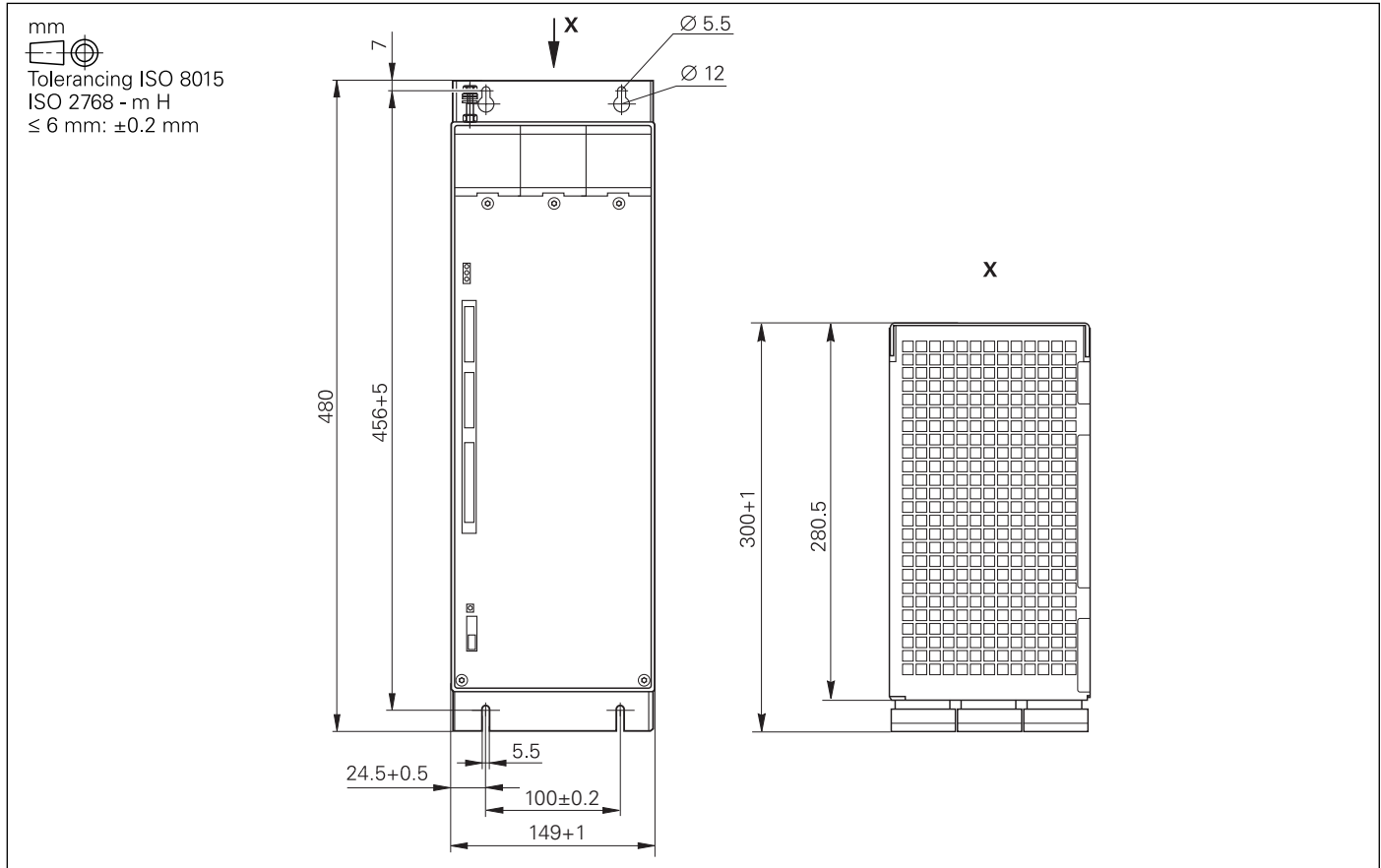

**UM 116DW, UM 117DW**

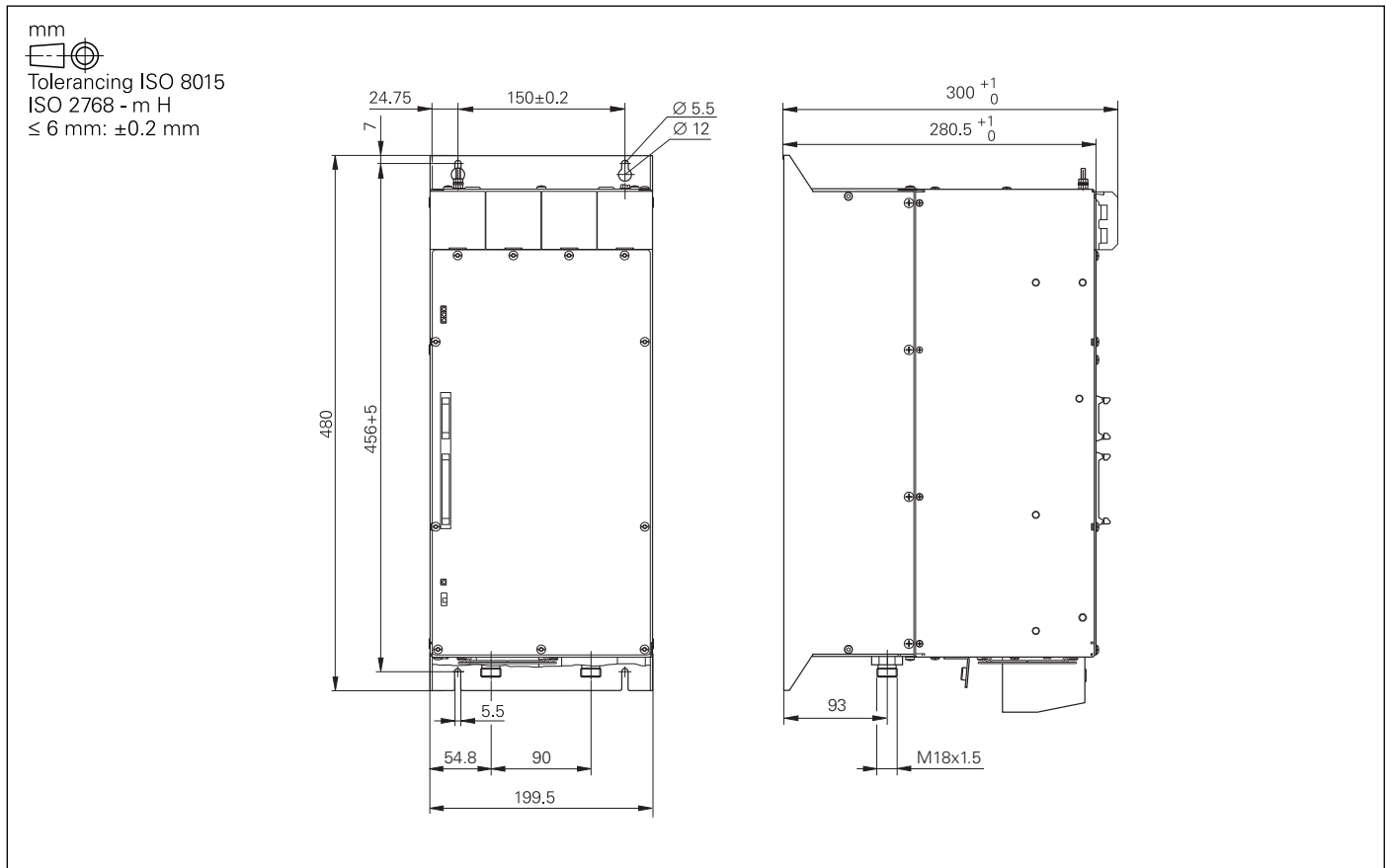

# UM 116 D with fan unit

mm



Tolerancing ISO 8015  
ISO 2768 - m H  
≤ 6 mm: ±0.2 mm

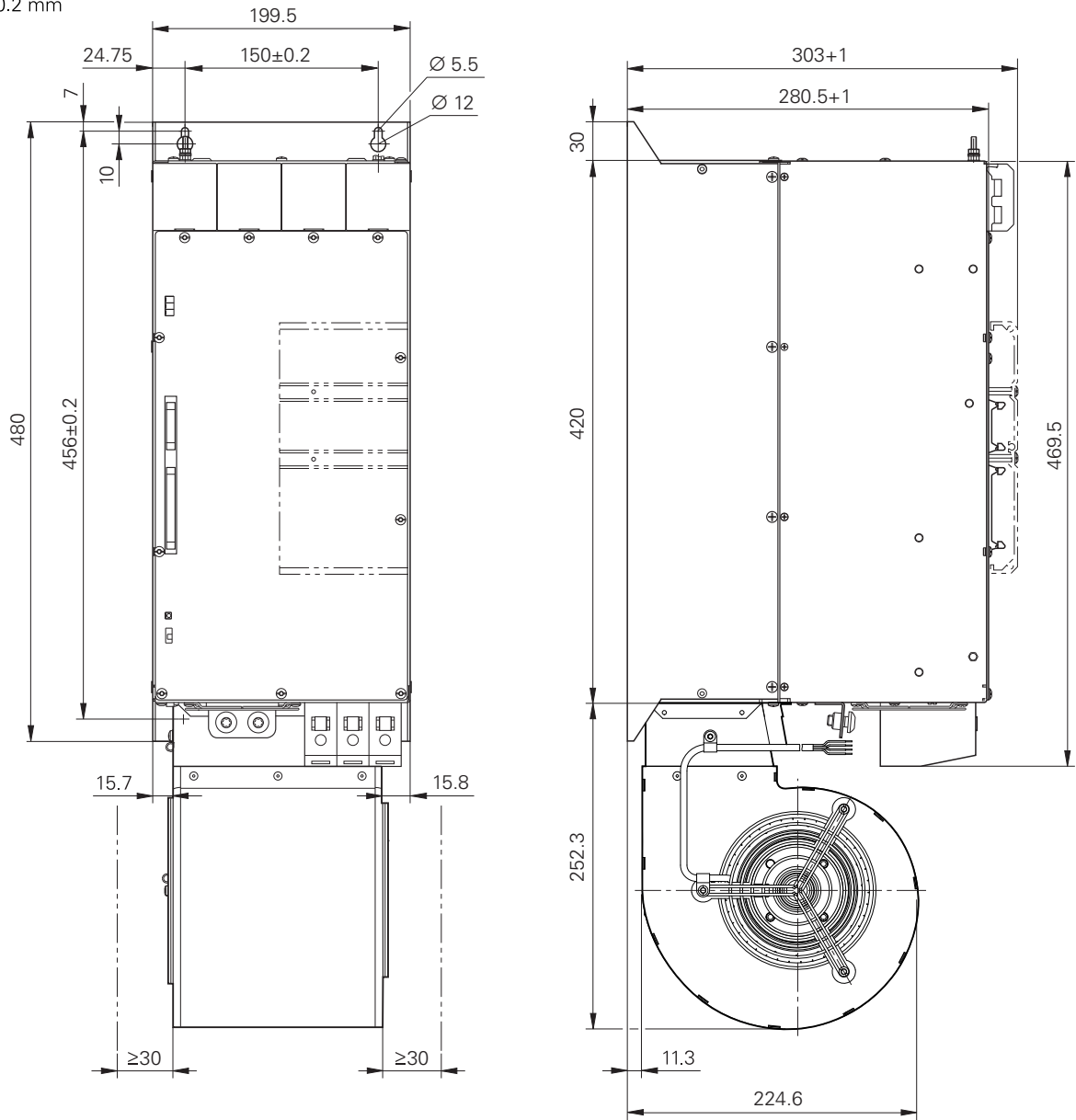

**SM 110**

mm  
  
 Tolerancing ISO 8015  
 ISO 2768 - m H  
 ≤ 6 mm: ±0.2 mm

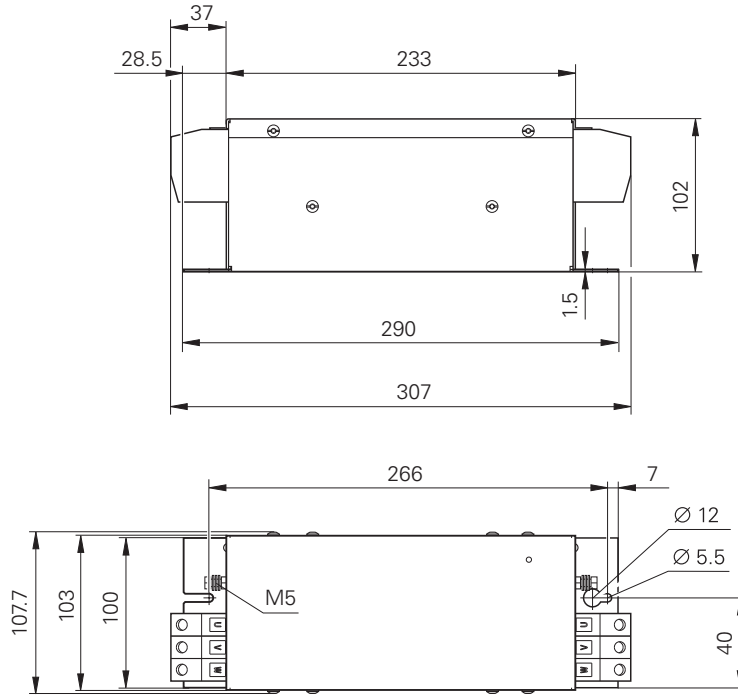

**SM 130**

mm  
  
 Tolerancing ISO 8015  
 ISO 2768 - m H  
 ≤ 6 mm: ±0.2 mm

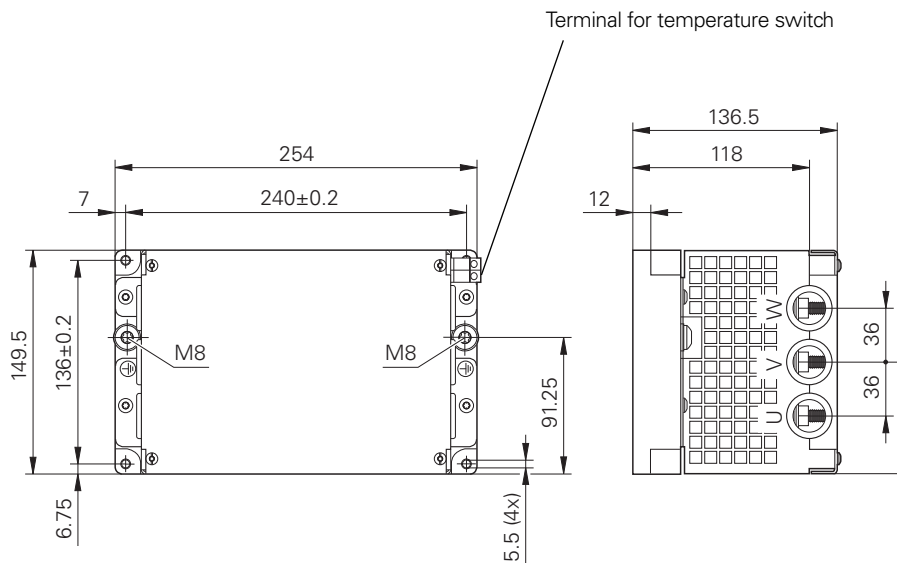

**MS 110, MS 111**

mm



Tolerancing ISO 8015  
ISO 2768 - m H  
≤ 6 mm: ±0.2 mm

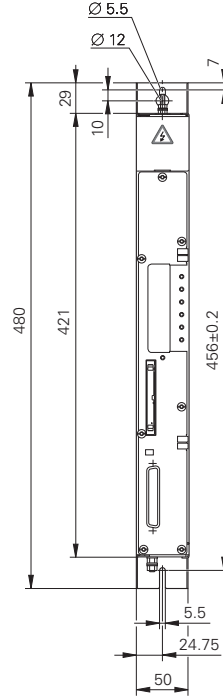
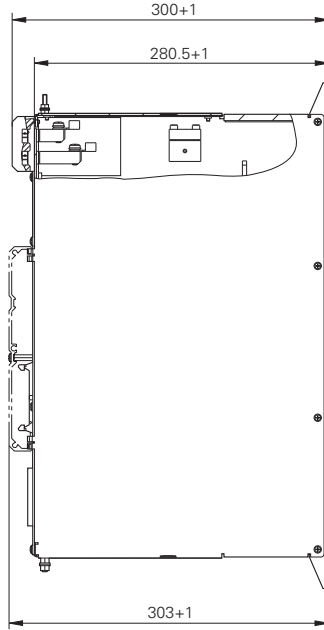
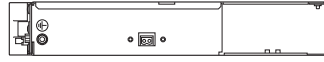

**Three-phase current capacitor**

mm



Tolerancing ISO 8015  
ISO 2768 - m H  
≤ 6 mm: ±0.2 mm

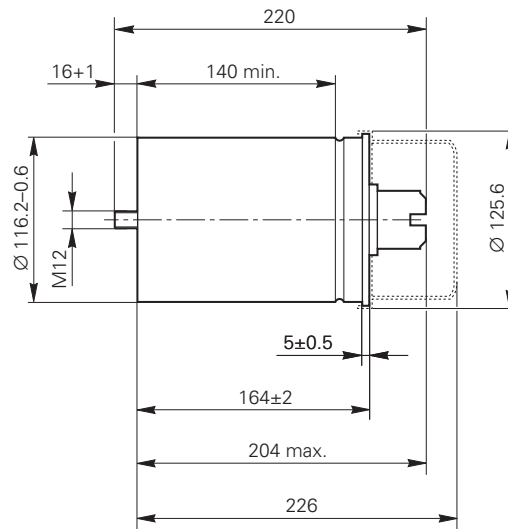
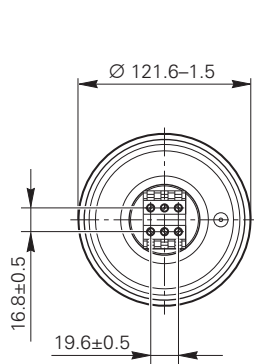

Cover included in items supplied.

### ZKF 110

mm  
  
Tolerancing ISO 8015  
ISO 2768 - m H  
≤ 6 mm: ±0.2 mm

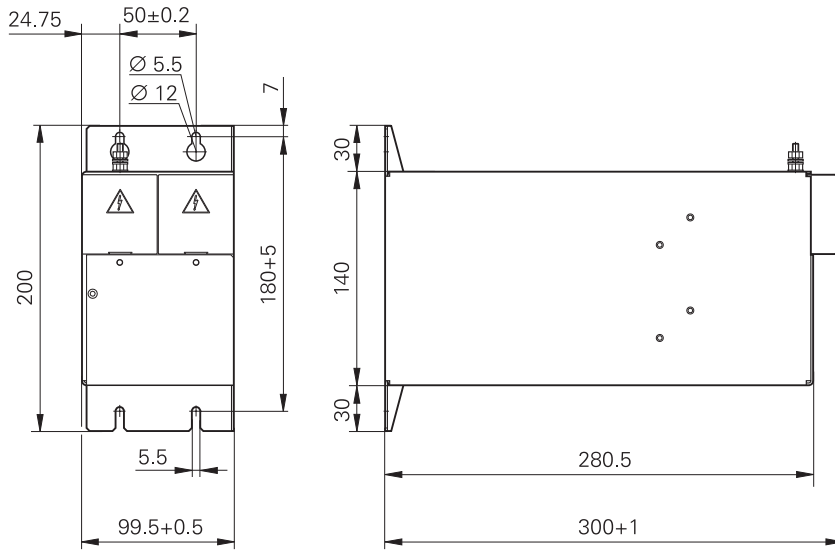

### ZKF 120, ZKF 130, ZKF 140, ZKF 150

mm  
  
Tolerancing ISO 8015  
ISO 2768 - m H  
≤ 6 mm: ±0.2 mm

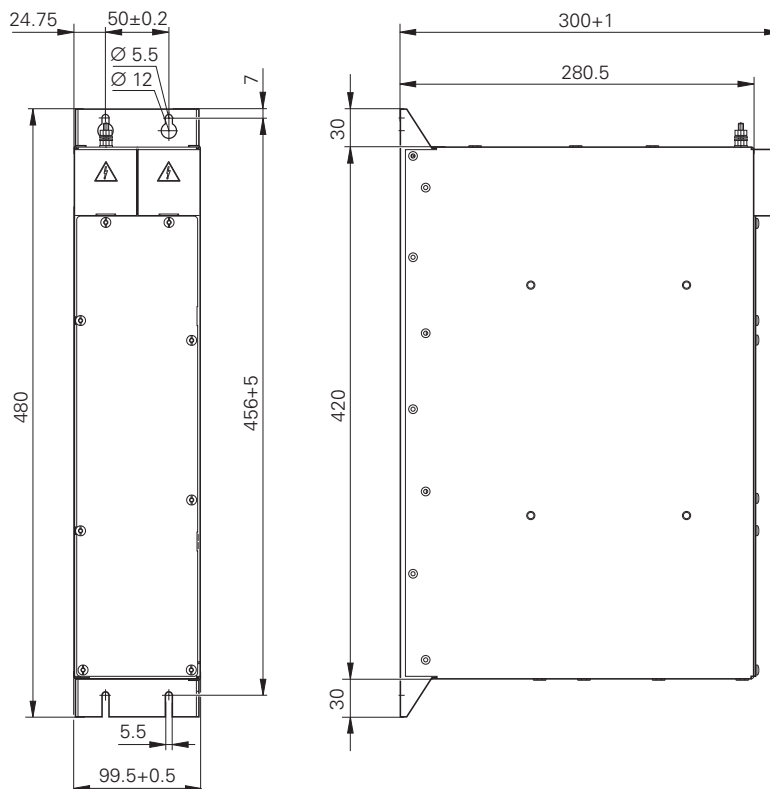

**KDR 120**

mm  
  
 Tolerancing ISO 8015  
 ISO 2768 - m H  
 ≤ 6 mm: ±0.2 mm

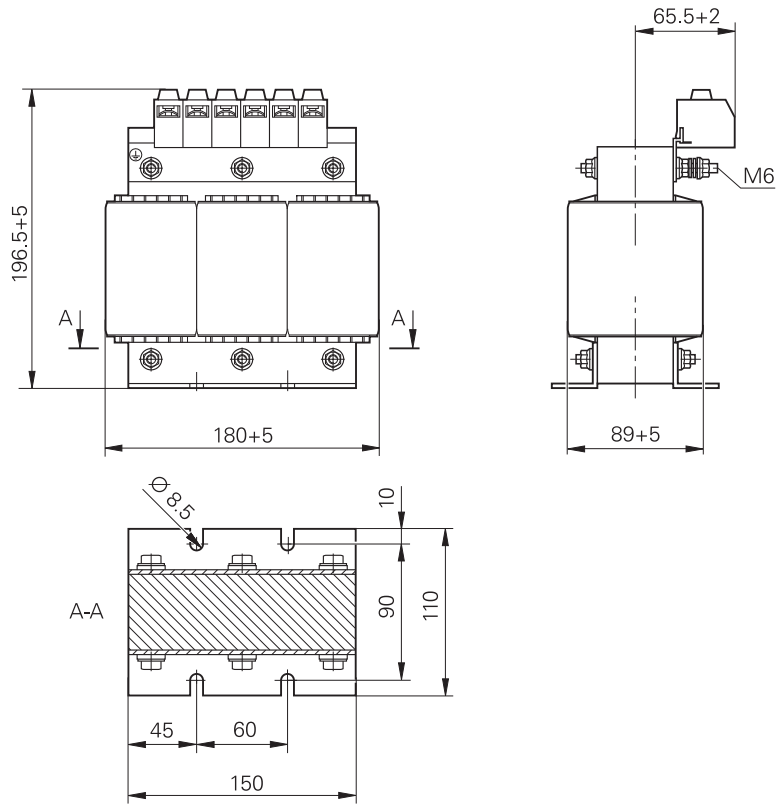

**KDR 130C**

mm  
  
 Tolerancing ISO 8015  
 ISO 2768 - m H  
 ≤ 6 mm: ±0.2 mm

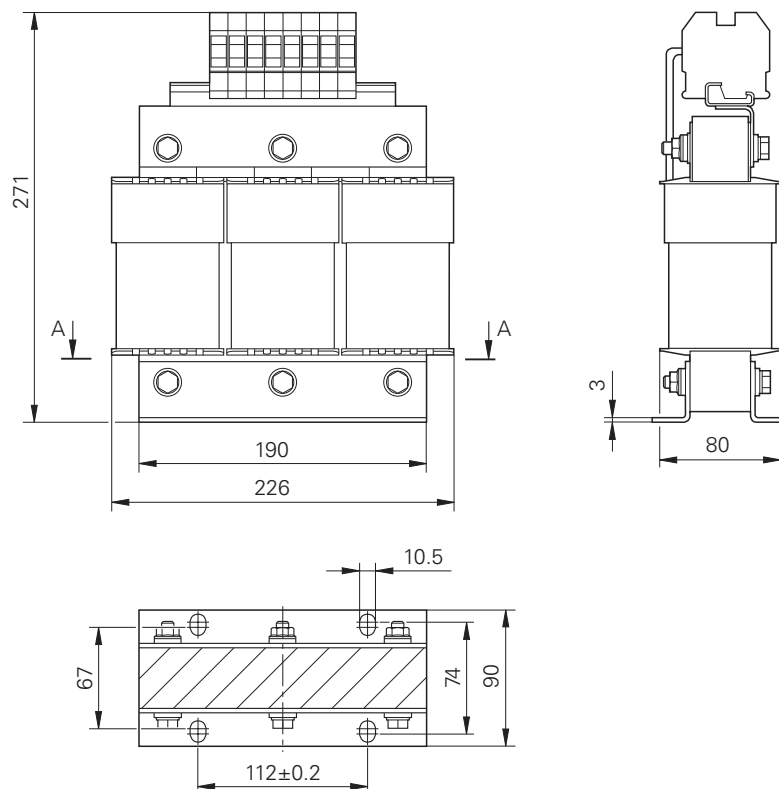

### KDR 140

mm  
  
Tolerancing ISO 8015  
ISO 2768 - m H  
≤ 6 mm: ±0.2 mm

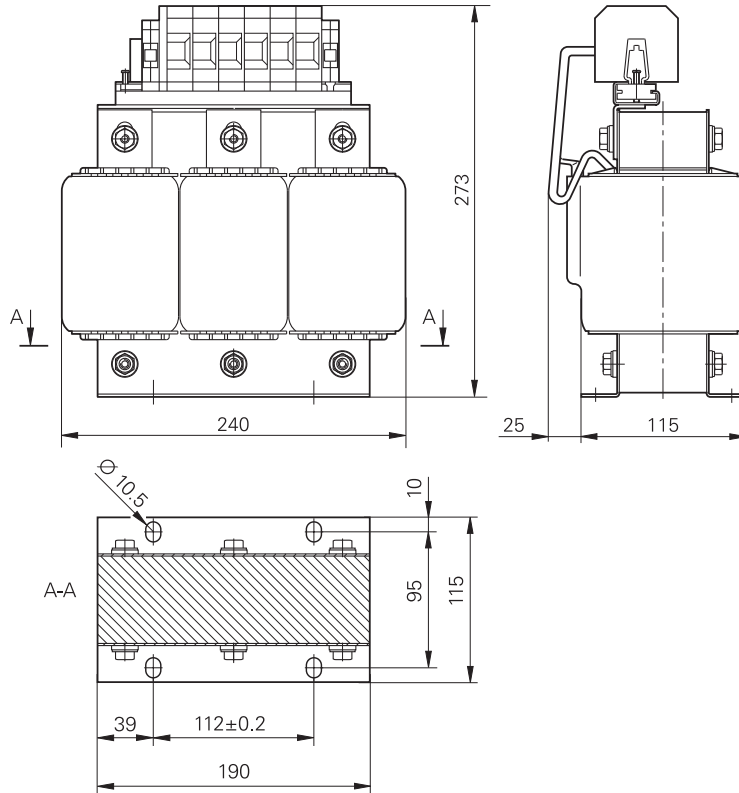

### KDR 150

mm  
  
Tolerancing ISO 8015  
ISO 2768 - m H  
≤ 6 mm: ±0.2 mm

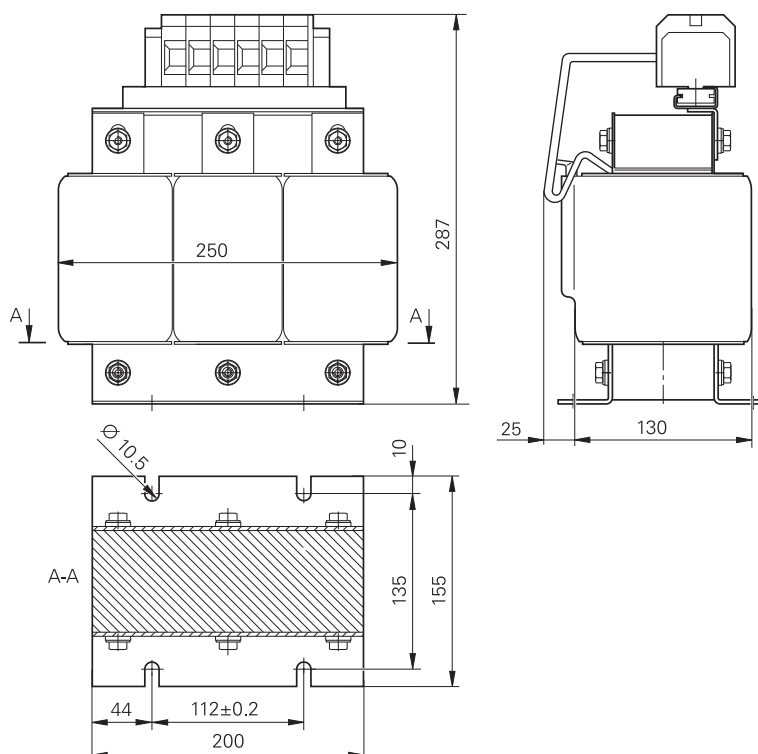



# KDR 160

mm



Tolerancing ISO 8015

ISO 2768 - m H

≤ 6 mm: ±0.2 mm

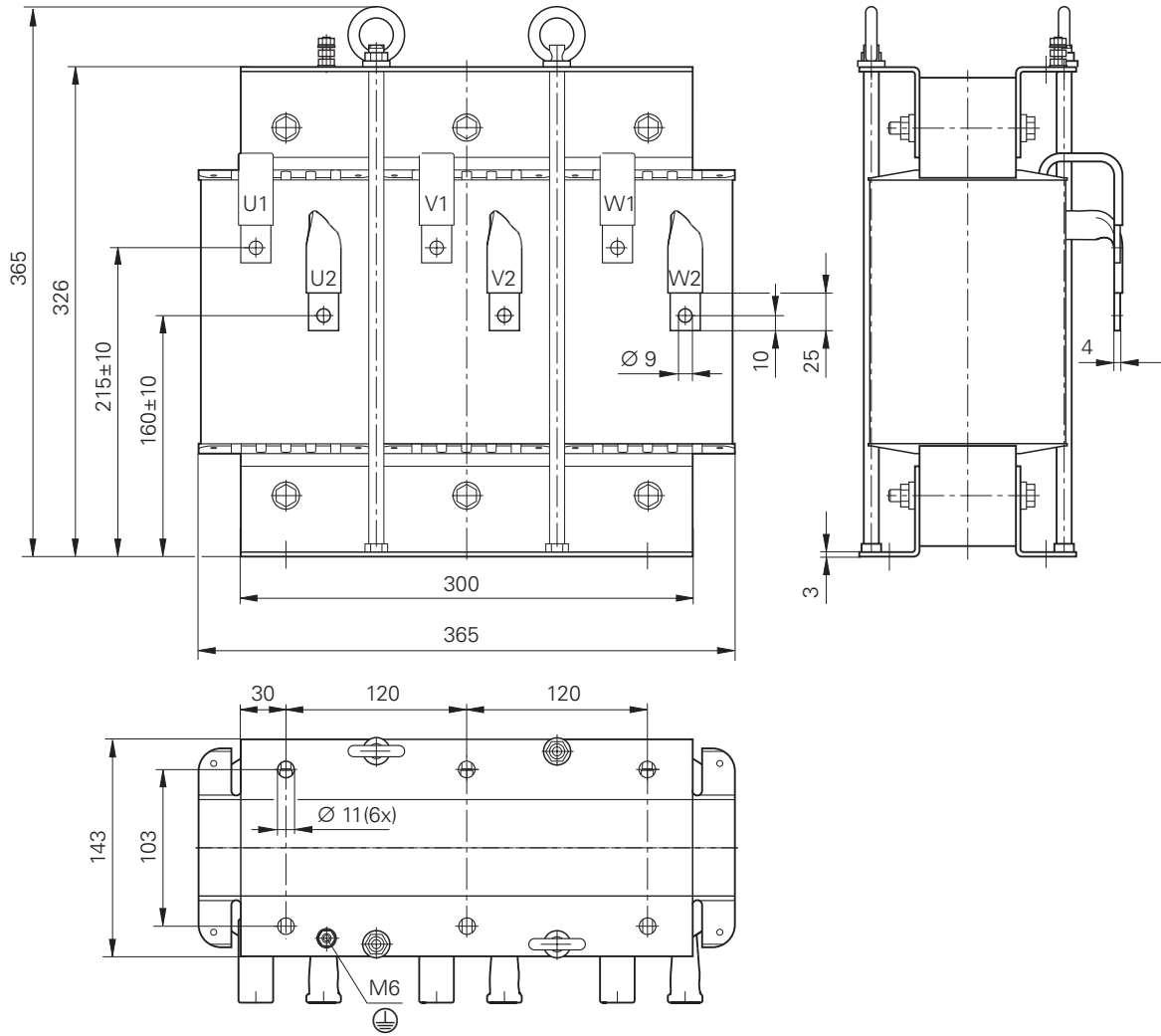

**KDR 170**

mm  
  
Tolerancing ISO 8015  
ISO 2768 - m H  
≤ 6 mm: ±0.2 mm

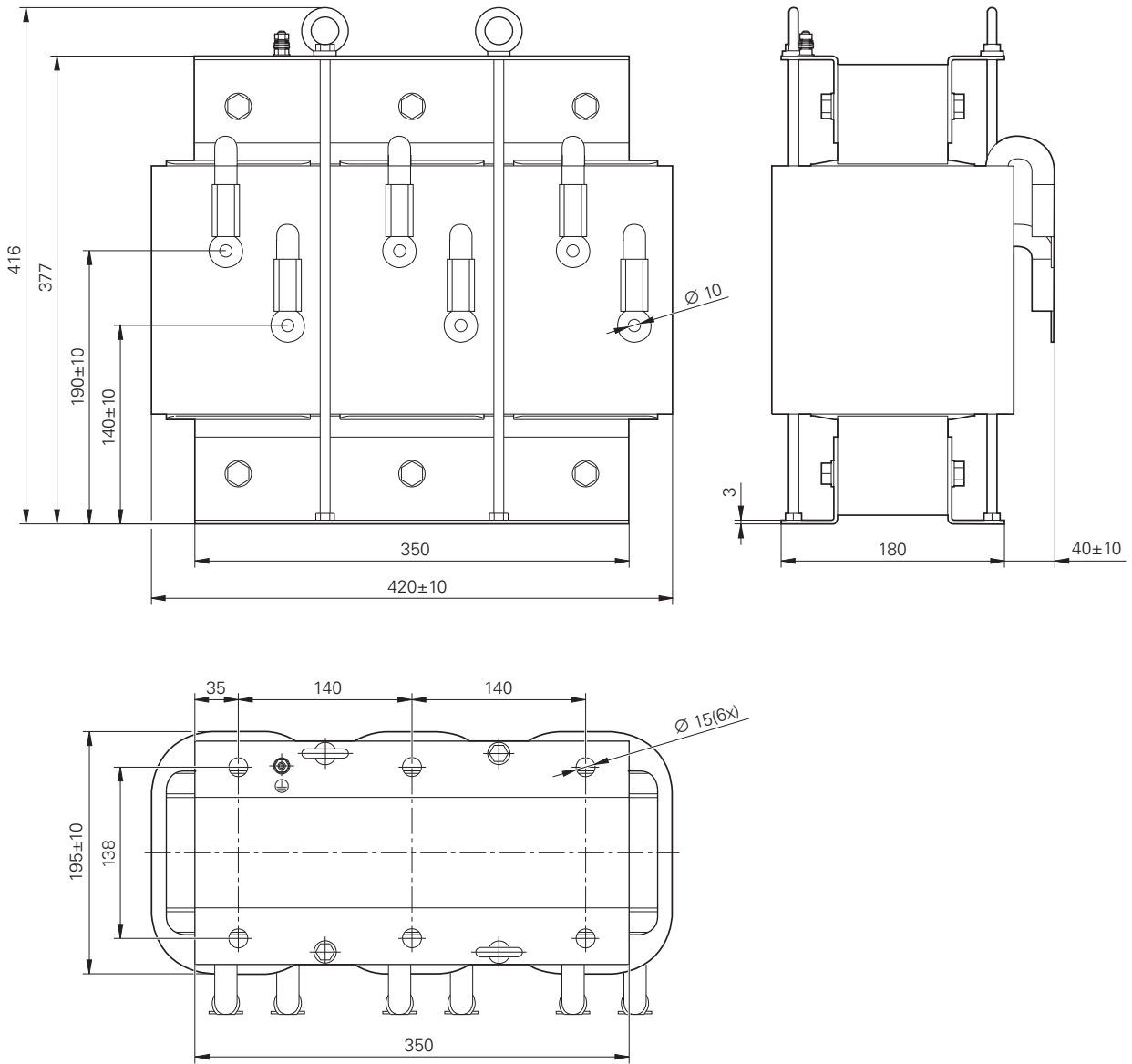

**EPCOS 35A**

mm  
  
 Tolerancing ISO 8015  
 ISO 2768 - m H  
 ≤ 6 mm: ±0.2 mm

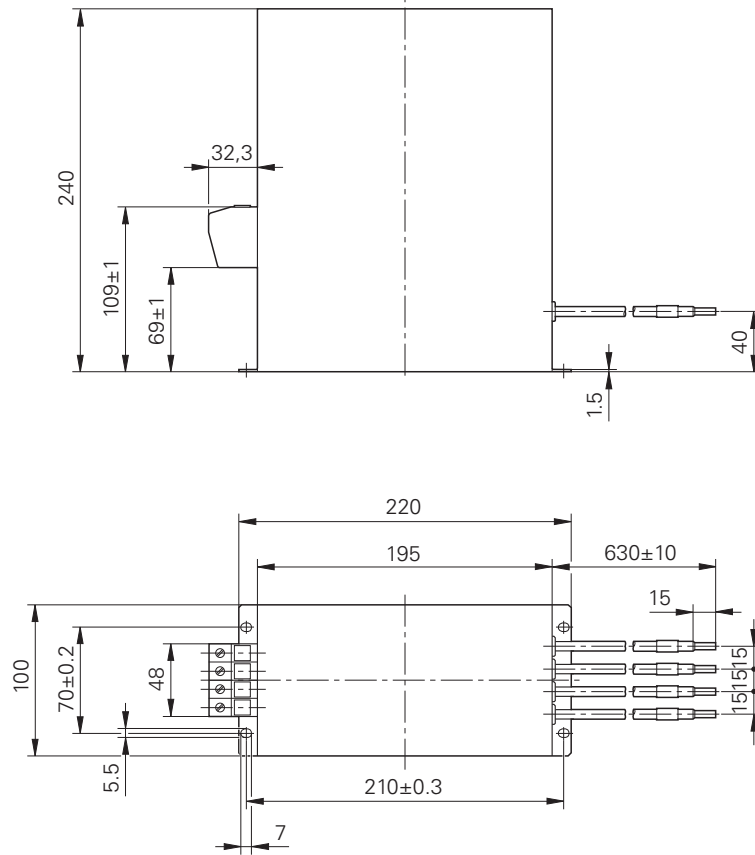

**EPCOS 80A**

mm  
  
 Tolerancing ISO 8015  
 ISO 2768 - m H  
 ≤ 6 mm: ±0.2 mm

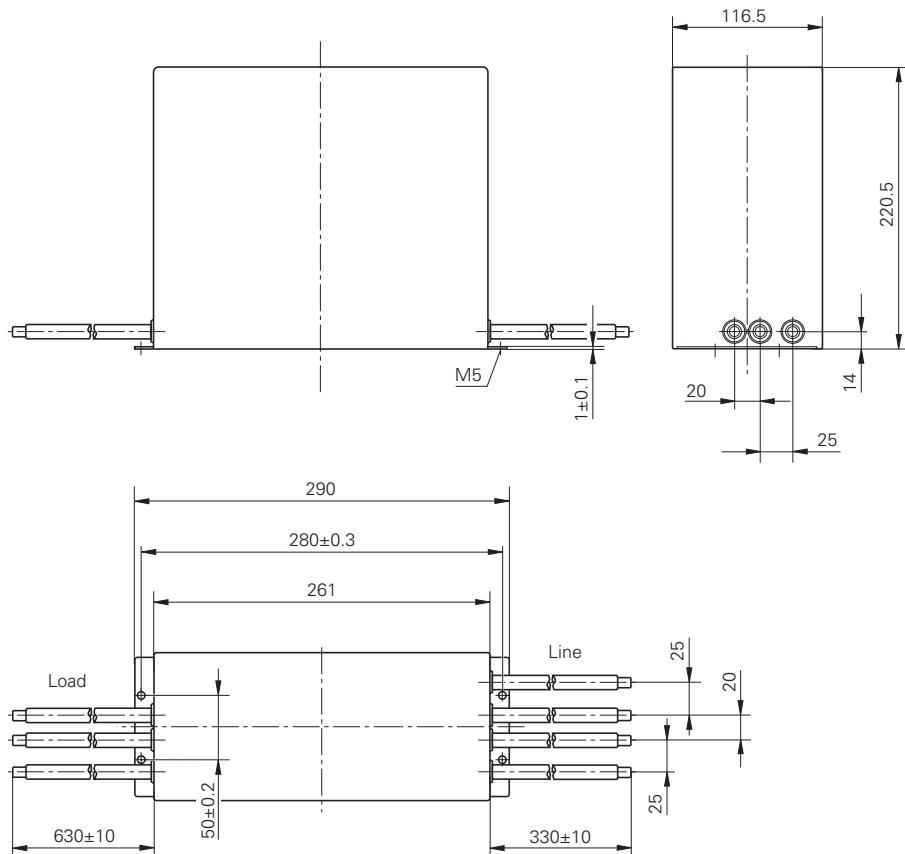

**EPCOS 120A**

mm  
Tolerancing ISO 8015  
ISO 2768 - m H  
≤ 6 mm: ±0.2 mm

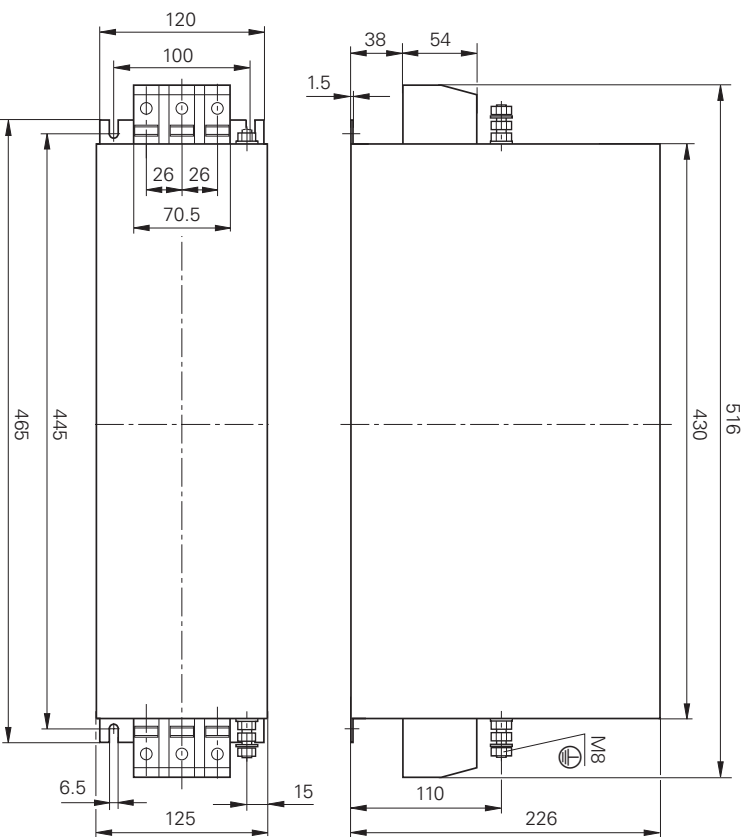

**EPCOS 200A**

mm  
Tolerancing ISO 8015  
ISO 2768 - m H  
≤ 6 mm: ±0.2 mm

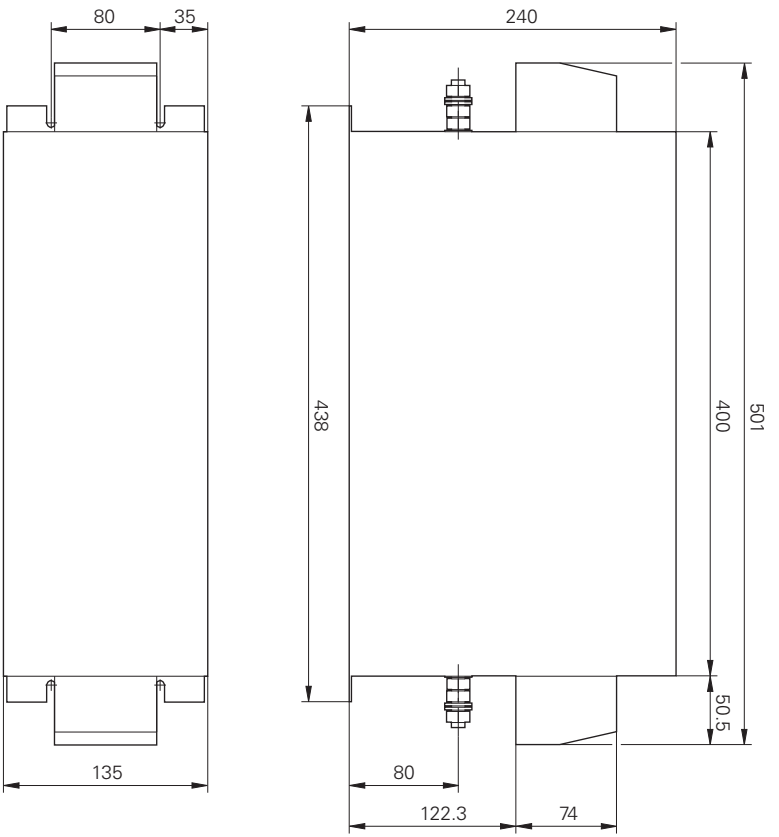

**UP 110, UP 120**

mm  
  
 Tolerancing ISO 8015  
 ISO 2768 - m H  
 ≤ 6 mm: ±0.2 mm

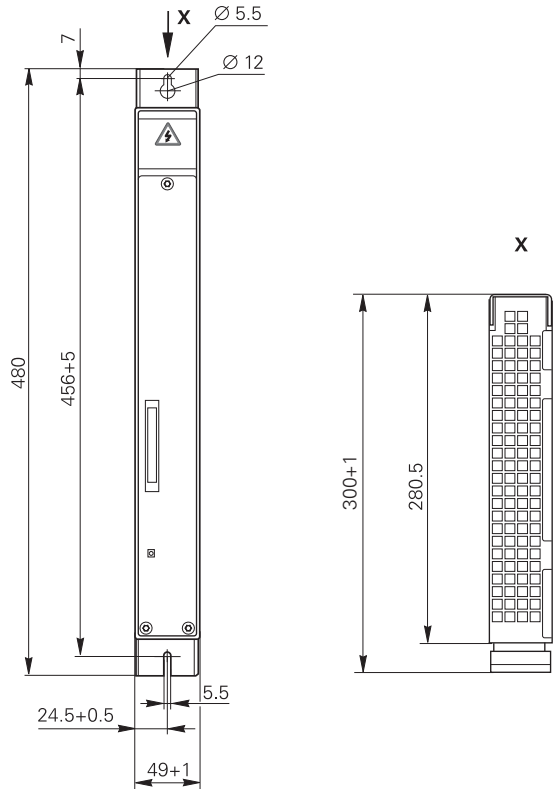

**Adapter module**

mm  
  
 Tolerancing ISO 8015  
 ISO 2768 - m H  
 ≤ 6 mm: ±0.2 mm

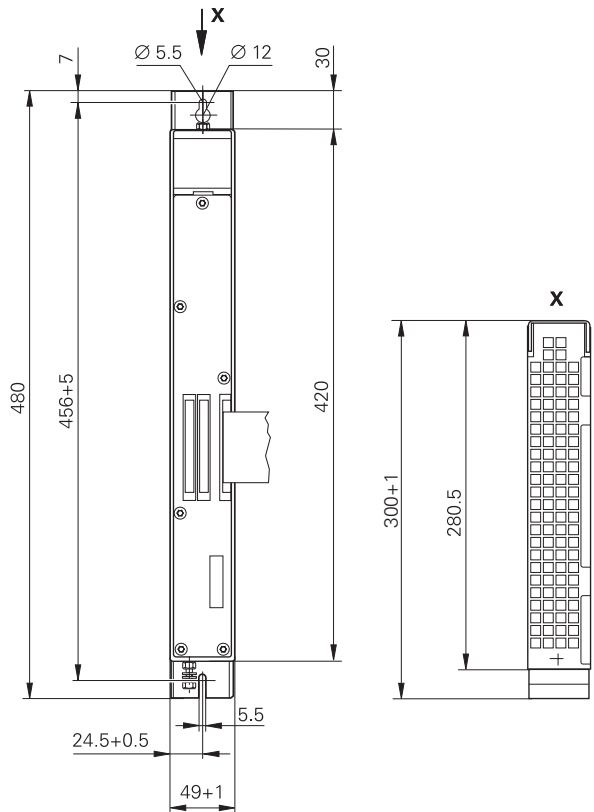

**PW 210**

mm  
Tolerancing ISO 8015  
ISO 2768 - m H  
≤ 6 mm: ±0.2 mm

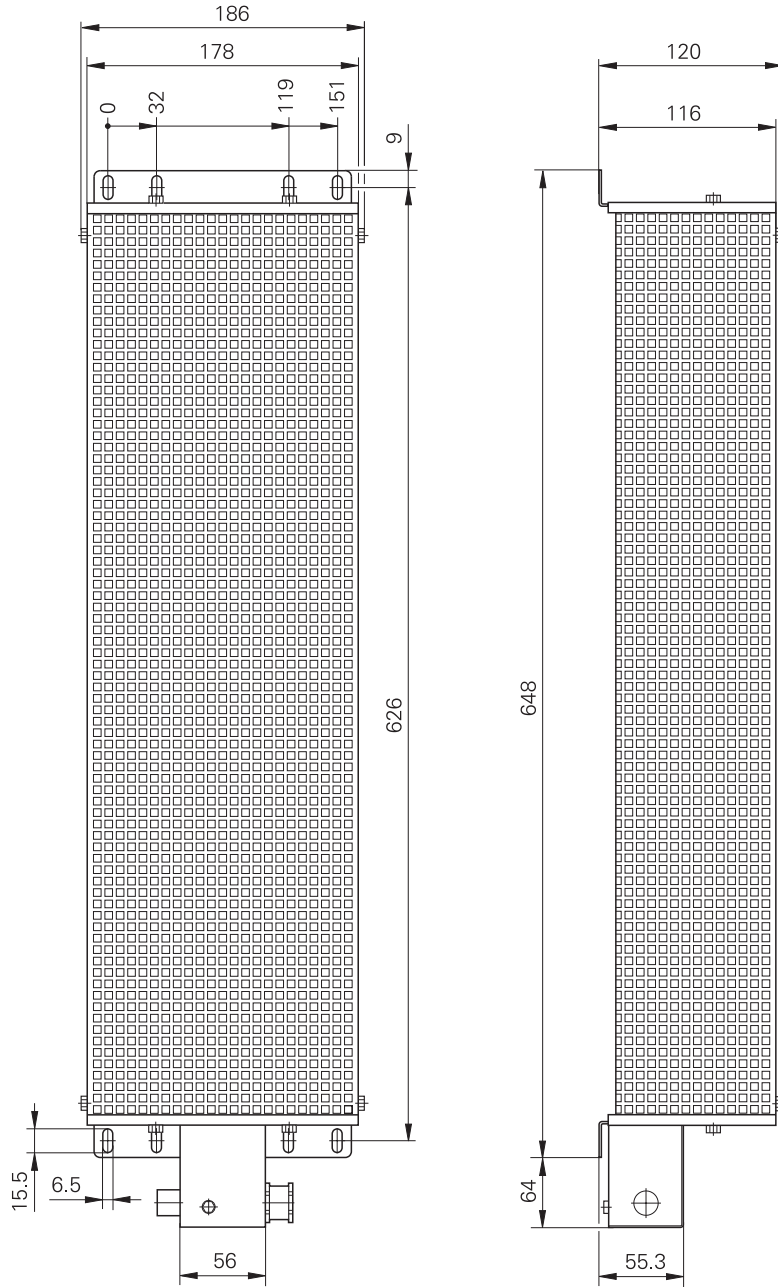

# Subject index

## A

Accessories for ribbon cables ..... 30  
 Adapter module ..... 28, 61  
 Axis-release module ..... 27

## B

Braking resistor ..... 23  
 Braking resistor module ..... 23

## C

Capacitor modules ..... 26  
 CMH 120 ..... 26  
 CML 110 ..... 26  
 Commutating reactor ..... 22  
 Compact inverters ..... 5, 10  
 Coolant connection ..... 24  
 Covers for the ribbon cables ..... 29

## D

DC-link filter ..... 24  
 DC-link voltage ..... 4  
 Double-row configuration ..... 34

## E

Electromagnetic compatibility ..... 42  
 EPCOS 35A ..... 22, 59  
 EPCOS 80A ..... 22, 59  
 EPCOS 120A ..... 22, 60  
 EPCOS 200A ..... 22, 60

## F

Fan cooling ..... 16  
 FLT-CP-3C-350 ..... 25  
 Functional safety (FS) ..... 4

## I

IOconfig software for PCs ..... 14

## K

KDR 120 ..... 22, 55  
 KDR 130 C ..... 22, 55  
 KDR 140 ..... 22, 56  
 KDR 150 ..... 22, 56  
 KDR 160 ..... 22, 57  
 KDR 170 ..... 22, 58

## L

Line filter ..... 22

## M

Modular inverters ..... 5, 16, 18  
 Mounting information ..... 41  
 MS 110 ..... 34, 53  
 MS 111 ..... 34, 53

## N

Non-regenerative compact inverters ..... 10  
 Non-regenerative inverters ..... 4

## P

Power modules ..... 16, 18  
 PW 210 ..... 23, 62

## R

Regenerative compact inverters ..... 8  
 Regenerative inverters ..... 4  
 Ribbon cable for PWM signals ..... 32  
 Ribbon cable for supply voltage ..... 30  
 Ribbon cable for unit bus ..... 31  
 Ribbon cables and covers ..... 6, 29

## S

SM 110 ..... 25, 52  
 SM 130 ..... 25, 52  
 Supply unit ..... 20  
 Surge protector ..... 25

## T

Three-phase current capacitor ..... 53

## U

UE 2xxD ..... 44  
 UE 210 D ..... 10  
 UE 211 D ..... 10  
 UE 212 D ..... 10  
 UE 230 D ..... 12  
 UE 240 D ..... 12  
 UE 241 D ..... 12  
 UE 242 D ..... 12  
 UEC 11x ..... 14  
 UEC 111 ..... 15, 43

UEC 112 ..... 15, 43  
 UEC 113 ..... 15, 43  
 UM 111 BD ..... 17, 49  
 UM 111 D ..... 17, 49  
 UM 112 D ..... 17, 49  
 UM 113 D ..... 17, 49  
 UM 114 D ..... 17, 49  
 UM 115 D ..... 18, 50  
 UM 116 D ..... 18  
 UM 116 DW ..... 18, 50  
 UM 117 DW ..... 18, 50  
 UM 121 BD ..... 18, 49  
 UM 121 D ..... 18, 49  
 UM 122 D ..... 18, 49  
 UMC 111 ..... 15, 43  
 UP 110 ..... 23, 61  
 UP 120 ..... 23, 61  
 UR 2xx D ..... 43  
 UR 230 D ..... 8  
 UR 240 D ..... 8  
 UR 242 D ..... 8  
 UV 130 D ..... 20, 48  
 UVR 120 D ..... 20, 45  
 UVR 130 D ..... 20, 45  
 UVR 140 D ..... 20, 45  
 UVR 150 D ..... 20, 45  
 UVR 160 D ..... 20, 46  
 UVR 160 DW ..... 20, 46  
 UVR 170 D ..... 20, 47  
 UVR 170 DW ..... 20, 48

## V

VAL-MS 230/FM ..... 25  
 Voltage-protection module ..... 25

## W

Water cooling ..... 16

## Z

ZKF 110 ..... 24, 54  
 ZKF 120 ..... 24, 54  
 ZKF 130 ..... 24, 54  
 ZKF 140 ..... 24, 54  
 ZKF 150 ..... 24, 54

# HEIDENHAIN

## DR. JOHANNES HEIDENHAIN GmbH

Dr.-Johannes-Heidenhain-Straße 5

83301 Traunreut, Germany

☎ +49 8669 31-0

FAX +49 8669 32-5061

E-mail: info@heidenhain.de

www.heidenhain.de

Vollständige und weitere Adressen siehe [www.heidenhain.de](http://www.heidenhain.de)  
For complete and further addresses see [www.heidenhain.de](http://www.heidenhain.de)

<b>DE</b>	<b>HEIDENHAIN Vertrieb Deutschland</b> 83301 Traunreut, Deutschland ☎ 08669 31-3132 FAX 08669 32-3132 E-Mail: hd@heidenhain.de	<b>ES</b>	<b>FARRESA ELECTRONICA S.A.</b> 08028 Barcelona, Spain www.farresa.es	<b>PL</b>	<b>APS</b> 02-384 Warszawa, Poland www.heidenhain.pl
	<b>HEIDENHAIN Technisches Büro Nord</b> 12681 Berlin, Deutschland ☎ 030 54705-240	<b>FI</b>	<b>HEIDENHAIN Scandinavia AB</b> 01740 Vantaa, Finland www.heidenhain.fi	<b>PT</b>	<b>FARRESA ELECTRÓNICA, LDA.</b> 4470 - 177 Maia, Portugal www.farresa.pt
	<b>HEIDENHAIN Technisches Büro Mitte</b> 07751 Jena, Deutschland ☎ 03641 4728-250	<b>FR</b>	<b>HEIDENHAIN FRANCE sarl</b> 92310 Sèvres, France www.heidenhain.fr	<b>RO</b>	<b>HEIDENHAIN Reprezentantă Romania</b> Braşov, 500407, Romania www.heidenhain.ro
	<b>HEIDENHAIN Technisches Büro West</b> 44379 Dortmund, Deutschland ☎ 0231 618083-0	<b>GB</b>	<b>HEIDENHAIN (G.B.) Limited</b> Burgess Hill RH15 9RD, United Kingdom www.heidenhain.co.uk	<b>RS</b>	Serbia → <b>BG</b>
	<b>HEIDENHAIN Technisches Büro Südwest</b> 70771 Leinfelden-Echterdingen, Deutschland ☎ 0711 993395-0	<b>GR</b>	<b>MB Milionis Vassilis</b> 17341 Athens, Greece www.heidenhain.gr	<b>RU</b>	<b>OOO HEIDENHAIN</b> 115172 Moscow, Russia www.heidenhain.ru
	<b>HEIDENHAIN Technisches Büro Südost</b> 83301 Traunreut, Deutschland ☎ 08669 31-1345	<b>HK</b>	<b>HEIDENHAIN LTD</b> Kowloon, Hong Kong E-mail: sales@heidenhain.com.hk	<b>SE</b>	<b>HEIDENHAIN Scandinavia AB</b> 12739 Skärholmen, Sweden www.heidenhain.se
		<b>HR</b>	Croatia → <b>SL</b>	<b>SG</b>	<b>HEIDENHAIN PACIFIC PTE LTD</b> Singapore 408593 www.heidenhain.com.sg
<b>AR</b>	<b>NAKASE SRL.</b> B1653AOX Villa Ballester, Argentina www.heidenhain.com.ar	<b>HU</b>	<b>HEIDENHAIN Kereskedelmi Képviselet</b> 1239 Budapest, Hungary www.heidenhain.hu	<b>SK</b>	<b>KOPRETINA TN s.r.o.</b> 91101 Trenčín, Slovakia www.kopretina.sk
<b>AT</b>	<b>HEIDENHAIN Techn. Büro Österreich</b> 83301 Traunreut, Germany www.heidenhain.de	<b>ID</b>	<b>PT Servitama Era Toolsindo</b> Jakarta 13930, Indonesia E-mail: ptset@group.gts.co.id	<b>SL</b>	<b>NAVO d.o.o.</b> 2000 Maribor, Slovenia www.heidenhain.si
<b>AU</b>	<b>FCR MOTION TECHNOLOGY PTY LTD</b> 3026 Victoria, Australia E-mail: sales@fcrmotion.com	<b>IL</b>	<b>NEUMO VARGUS MARKETING LTD.</b> Tel Aviv 61570, Israel E-mail: neumo@neumo-vargus.co.il	<b>TH</b>	<b>HEIDENHAIN (THAILAND) LTD</b> Bangkok 10250, Thailand www.heidenhain.co.th
<b>BE</b>	<b>HEIDENHAIN NV/SA</b> 1760 Roosdaal, Belgium www.heidenhain.be	<b>IN</b>	<b>HEIDENHAIN Optics &amp; Electronics India Private Limited</b> Chetpet, Chennai 600 031, India www.heidenhain.in	<b>TR</b>	<b>T&amp;M Mühendislik San. ve Tic. LTD. ŞTİ.</b> 34775 Y. Dudullu – Ümraniye-Istanbul, Turkey www.heidenhain.com.tr
<b>BG</b>	<b>ESD Bulgaria Ltd.</b> Sofia 1172, Bulgaria www.esd.bg	<b>IT</b>	<b>HEIDENHAIN ITALIANA S.r.l.</b> 20128 Milano, Italy www.heidenhain.it	<b>TW</b>	<b>HEIDENHAIN Co., Ltd.</b> Taichung 40768, Taiwan R.O.C. www.heidenhain.com.tw
<b>BR</b>	<b>DIADUR Indústria e Comércio Ltda.</b> 04763-070 – São Paulo – SP, Brazil www.heidenhain.com.br	<b>JP</b>	<b>HEIDENHAIN K.K.</b> Tokyo 102-0083, Japan www.heidenhain.co.jp	<b>UA</b>	<b>Gertner Service GmbH Büro Kiev</b> 01133 Kiev, Ukraine www.heidenhain.ua
<b>BY</b>	<b>GERTNER Service GmbH</b> 220026 Minsk, Belarus www.heidenhain.by	<b>KR</b>	<b>HEIDENHAIN Korea LTD.</b> Gasan-Dong, Seoul, Korea 153-782 www.heidenhain.co.kr	<b>US</b>	<b>HEIDENHAIN CORPORATION</b> Schaumburg, IL 60173-5337, USA www.heidenhain.com
<b>CA</b>	<b>HEIDENHAIN CORPORATION</b> Mississauga, Ontario L5T2N2, Canada www.heidenhain.com	<b>MX</b>	<b>HEIDENHAIN CORPORATION MEXICO</b> 20290 Aguascalientes, AGS., Mexico E-mail: info@heidenhain.com	<b>VE</b>	<b>Maquinaria Diekmann S.A.</b> Caracas, 1040-A, Venezuela E-mail: purchase@diekmann.com.ve
<b>CH</b>	<b>HEIDENHAIN (SCHWEIZ) AG</b> 8603 Schwerzenbach, Switzerland www.heidenhain.ch	<b>MY</b>	<b>ISOSERVE SDN. BHD.</b> 43200 Balakong, Selangor E-mail: sales@isoserve.com.my	<b>VN</b>	<b>AMS Co. Ltd</b> HCM City, Vietnam E-mail: davidgoh@amsvn.com
<b>CN</b>	<b>DR. JOHANNES HEIDENHAIN (CHINA) Co., Ltd.</b> Beijing 101312, China www.heidenhain.com.cn	<b>NL</b>	<b>HEIDENHAIN NEDERLAND B.V.</b> 6716 BM Ede, Netherlands www.heidenhain.nl	<b>ZA</b>	<b>MAFEMA SALES SERVICES C.C.</b> Midrand 1685, South Africa www.heidenhain.co.za
<b>CZ</b>	<b>HEIDENHAIN s.r.o.</b> 102 00 Praha 10, Czech Republic www.heidenhain.cz	<b>NO</b>	<b>HEIDENHAIN Scandinavia AB</b> 7300 Orkanger, Norway www.heidenhain.no		
<b>DK</b>	<b>TPTEKNIK A/S</b> 2670 Greve, Denmark www.tp-gruppen.dk	<b>PH</b>	<b>MACHINEBANKS' CORPORATION</b> Quezon City, Philippines 1113 E-mail: info@machinebanks.com		

